

# POSITAL

FRABA

## USER MANUAL TILTIX MEMS INCLINOMETER WITH CANOPEN INTERFACE



# CANopen®

AMERICAS  
FRABA Inc.  
1800 East State Street, Suite 148  
Hamilton, NJ 08609-2020, USA  
T +1 609 750-8705  
[www.posita.com](http://www.posita.com), [info@posita.com](mailto:info@posita.com)

EUROPE  
FRABA AG  
Carlswerkstrasse 13c  
51063 Cologne, GERMANY  
T +49 221 96213-0, F +49 221 96213-20  
[www.posita.com](http://www.posita.com), [info@posita.eu](mailto:info@posita.eu)

ASIA  
FRABA Pte. Ltd.  
20 Kallang Avenue  
Singapore 339411, SINGAPORE  
T +65 6514 8880, F +65 6271 1792  
[www.posita.com](http://www.posita.com), [info@posita.sg](mailto:info@posita.sg)

# POSITAL

## FRABA

### USER MANUAL

### TILTIX MEMS INCLINOMETER WITH CANOPEN INTERFACE

## 1 Content

1	Content .....	2	7.8	Object 1800h: 1st Transmit PDO Communication Parameter .....	19
2	General Safety Advice .....	4	7.9	Object 1801h: 2nd Transmit PDO Communication Parameter .....	20
2.1	Important Information .....	4	7.10	Transmission Mode .....	20
3	About this Manual .....	5	7.11	Inhibit Time .....	21
3.1	Background .....	5	7.12	Event Timer .....	21
3.2	Version Management .....	5	7.13	Cyclic Timer .....	21
3.3	Imprint .....	5	7.14	Object 1A00h: 1st Transmit PDO Mapping Parameter .....	22
3.4	Copyright .....	5	7.15	Object 1A01h: 2nd Transmit PDO Mapping Parameter .....	22
3.5	User Annotation .....	5	7.16	Types of SDO .....	22
3.6	Document History .....	5	8	Working with Schneider PLC .....	24
4	Introduction .....	6	8.1	Types of SDO .....	24
4.1	TILTIX Inclinomter .....	6	8.2	Types of SDO .....	24
4.2	CANopen Interface .....	6	8.3	24	
4.3	TILTIX CANopen .....	6	8.4	Software Project Information .....	25
4.4	Typical Applications of TILTIX .....	7	8.5	Controller Description .....	25
5	TILTIX – Modes and Parameter .....	8	8.6	CANopen Master Configuration .....	25
5.1	Pre-Operational Mode .....	9	8.7	Connection Network Setup .....	26
5.2	Operational Mode .....	9	9	Configuration .....	27
5.3	Stopped Mode .....	10	9.1	TILTIX Process Data Objects (PDO) Mapping .....	27
5.4	Re-Initialization of the Inclinomter ....	10	9.2	TILTIX CANopen Node Configuration	27
5.5	Boot-up Procedur .....	11	9.3	CANopen bus network configuratio....	27
5.6	Usage of Layer Settings Service (LSS) 11		9.4	Linking of CANOpen Master and TILTIX Transmit-PDOs .....	28
6	Installation .....	12	9.5	TILTIX & Controller Memory Configuration .....	28
6.1	Accessories .....	12	9.6	Debugging .....	28
6.2	Pin Assignement .....	12	9.7	Run .....	30
6.3	Installation Precautions .....	12	9.8	Resetting CANOpen Communication.	30
6.4	Mounting Instructions .....	13	9.9	Resetting CANOpen Nodes .....	30
6.5	Bus Termination .....	13	9.10	Position Readout .....	31
6.6	LED Definition .....	14	9.11	Readout Using Animation Table .....	31
6.7	Measurement Axes .....	15	10	Frequently Asked Questions .....	33
7	TILTIX Software Configuration .....	16	11	Appendix A: TILTIX CANopen Objects	38
7.1	Default Factory Settings .....	16	11.1	Object 1000h: Device Type .....	38
7.2	Active Programming Objects .....	16			
7.3	Programmable Parameters .....	17			
7.4	Command Description .....	17			
7.5	Data Length of Commands .....	17			
7.6	Frequently Used Commands .....	18			
7.7	PDO Transmission .....	19			

# POSITAL

---

## FRABA

### USER MANUAL

#### TILTIX MEMS INCLINOMETER WITH CANOPEN INTERFACE

11.2	Object 1001h: Error Register .....	38	11.33	Object 6022h: Slope Lateral16 Preset Value.....	51
11.3	Object 1003h: Pre-Defined Error Field	38	11.34	Object 6023h: Slope Lateral16 Offset	51
11.4	Object 1005h: COB-ID Sync.....	39	11.35	Object 6024h: Differential Slope Lateral16 Offset .....	51
11.5	Object 1008h: Mfr Device Name.....	39	11.36	Object 6114h: Differential Slope Long32 Offset (ACS360) .....	52
11.6	Object 1009h: Mfr Hardware Version .	39	12	Appendix C: Output Graphs.....	56
11.7	Object 100Ah: Mfr Software Version ..	39	12.1	TILTIX 360: CANopen Output Values	56
11.8	Object 100Ch: Guard Time.....	39	12.2	TITIX 080 : CANopen Output Values .	56
11.9	Object 100Dh: Life Time Factor .....	40	13	Glossary .....	58
11.10	Object 1010h: Store Parameters .....	40	14	Disclaimer.....	60
11.11	Object 1011h: Restore Parameters....	41			
11.12	Object 1014h: COB-ID Emergency ....	41			
11.13	Object 1016h: Consumer Heartbeat Time.....	42			
11.14	Object 1017h: Producer Heartbeat Time	42			
11.15	Object 1018: Identity Object .....	42			
11.16	Object 2200h: Cyclic Timer .....	43			
11.17	Object 2300h: Save Parameter with Reset .....	43			
11.18	Object 2600h: Preset X-Axis (80° Version) / Preset (360° Version) .....	43			
11.19	Object 2601h: Preset Y-Axis (80° Version).....	44			
11.20	Object 3000h: Node Number .....	44			
11.21	Object 3001h: Baud rate .....	45			
11.22	Object 3002h: Termination Resistor...	45			
11.23	Object 3022h: Digital Recursive Filter	46			
11.24	Object 3100h: Moving Average Filter .	46			
11.25	Object 6000h: Resolution .....	46			
11.26	Object 6010h: Slope Long16 .....	47			
11.27	Object 6011h: Slope Long16 Operating Parameter .....	47			
11.28	Object 6012h: Slope Long16 Preset Value.....	48			
11.29	Object 6013h: Slope Long16 Offset ...	48			
11.30	Object 6014h: Differential Slope Long16 Offset .....	49			
11.31	Object 6020h: Slope Lateral16 .....	49			
11.32	Object 6021h: Slope Lateral16 Operating Parameter .....	50			

### USER MANUAL

### TILTIX MEMS INCLINOMETER WITH CANOPEN INTERFACE

## 2 General Safety Advice

### 2.1 Important Information

Read these instructions carefully, and have a look at the equipment to become familiar with the device before trying to install, operate, or maintain it.

The following special messages may appear throughout this documentation or on the equipment to warn of potential hazards or to call attention towards information that clarifies/simplifies a procedure.

**Please Note:** Electrical equipment should be serviced only by qualified personnel. No responsibility is assumed by POSITAL for any consequences arising out of the use of this material. This document is not intended as an instruction manual for untrained personnel.



The addition of this symbol to a Danger or Warning safety label indicates that an electrical hazard exists, which will result in personal injury if the instructions are not followed.



This is the safety alert symbol. It is used to alert you to potential personal injury hazards. Obey all safety messages that follow this symbol to avoid possible injury or death.

### USER MANUAL

### TILTIX MEMS INCLINOMETER WITH CANOPEN INTERFACE

## 3 About this Manual

### 3.1 Background

This user manual explains how to install and configure the TILTIX inclinometer with a CANopen

interface with illustrations from a Schneider TWIDO® PLC.

### 3.2 Version Management

- Updated On: 20141125
- Document Name:  
Manual\_TILTIX\_CANopen\_General.pdf

### 3.3 Imprint

FRABA B.V.  
Jan Campertstraat 5,  
NL-6416 SG Heerlen  
T +49 221-96213-0  
info@fraba.com, www.fraba.com

### 3.4 Copyright

CANopen® and CiA® are registered community trademarks of CAN in Automation e.V.

© FRABA B.V., all rights reserved – Claims copyright on this documentation. It is not allowed to modify, extend, or hand over to a third party and to

copy this documentation without written approval by FRABA B.V. Nor is any liability assumed for damages resulting from the use of the information contained herein. Further, this publication and features described herein are subject to change without notice.

### 3.5 User Annotation

All readers are highly welcome to send us feedback and comments about this document.

Depending on your region you can reach us by

e-mail at the following e-mail addresses. For America [info@posital.com](mailto:info@posital.com), for Asia [info@fraba.sg](mailto:info@fraba.sg), for Europe [info@posital.eu](mailto:info@posital.eu).

### 3.6 Document History

Document	Manual_TILTIX_CANopen_General.pdf
Created	2011/10/31
Author	ANA
Reviewers	MMO / DPR
Versions	First Release – 20111031 Second Release – 20141125 Third Release - 20171127

### USER MANUAL

### TILTIX MEMS INCLINOMETER WITH CANOPEN INTERFACE

## 4 Introduction

This manual explains how to install and configure the TILTIX gravity referenced inclinometers with a CANopen interface, suitable for industrial, military

and heavy duty applications. The TILTIX CANopen is based on the DS410 standard.

### 4.1 TILTIX Inclinometer

TILTIX inclinometers sense and measure the angle of tilt (inclination/slope/elevation) of an object with respect to the force of gravity.

The TILTIX series of inclinometers, both industrial and heavy-duty lines, are available in two variants. First, a single axis measurement variant with a range of 360° and the other variant, a dual axis measurement capable TILTIX model with a range of ±80°.

The basic principle behind this TILTIX inclinometer is a Micro-Electro-Mechanical Systems (MEMS) sensor cell that is embedded to a fully molded ASIC. The angle is measured with the relative change in electrical capacitance in the MEMS cell.

### 4.2 CANopen Interface

CANopen is based on the Controller Area Network (CAN) that was developed by automotive industries in the 80s. The application protocol CANopen was introduced by the multi-vendor association CAN in Automation (CiA) to ensure a full compatibility of industrial automation products. It is a multiple access system (maximum: 127 devices), which means that all devices can access the bus. These devices are the components of the CANopen bus.

In simple terms, CANopen works as a client-server model. Each device checks whether the bus is free, and if it is free the device can send messages. If two devices try to access the bus at the same time, the device with the higher priority level has permission to send its message first. Devices with the lowest priority level must cancel their data transfer and wait before re-trying to send their message.

### 4.3 TILTIX CANopen

The TILTIX CANopen inclinometer corresponds to the inclinometer profile DS 410 CANopen standards. It is available in industrial and heavy-duty housings, and two measurement axes variants. The single axis measurement variant with a range of 360° and a dual axis measurement capable TILTIX model with a range of ±80°. In addition to

high resolution, accuracy and protection class of IP69K, it has built-in active linearization and temperature compensation. This makes TILTIX suitable for rugged environments and versatile applications in industrial, heavy duty and military applications.

### USER MANUAL

#### TILTIX MEMS INCLINOMETER WITH CANOPEN INTERFACE

The inclinometer supports the following operating modes:

- Polled mode: The position value is transmitted only on request.
- Cyclic mode: The position value is sent cyclically (regular, adjustable intervals) on the bus.
- SYNC mode: The position value is sent after a synchronization message (SYNC) is received. The position value is sent every  $n$  SYNCs ( $n \geq 1$ ).
- State change mode: The position value is transmitted whenever the position of the inclinometer changes (minimum time interval settable).

Various software tools for configuration and parameter-setting are available from different suppliers. It is easy to align and program the inclinometers using the EDS (electronic data sheet) configuration file provided. (Refer to section 3.1)

#### 4.4 Typical Applications of TILTIX

- Cranes and Construction Machinery
- Medical Systems
- Elevated Platforms
- Mobile Lifts and Fire Engines
- Automated Guided Vehicles (AGV)
- Automatic Assembling Machinery
- Boring and Drilling Applications
- Levelling and Flattening

### USER MANUAL

#### TILTIX MEMS INCLINOMETER WITH CANOPEN INTERFACE

## 5 TILTIX – Modes and Parameter

The purpose of this chapter is to describe the available configuration parameters of the TILTIX inclinometers with CANopen interface. Before going into details the following information describes useful technical terms and acronyms for CANopen network communication.

Node-ID	In the CAN network each device has a Node-ID that is used to address the device in the network and to define it's priority of
EDS (Electronic Data Sheet)	An EDS file describes the communication properties of a device on the CAN network (baud rates, transmission types, I/O features, etc.). It is provided by the device manufacturer and is used in the configuration tool to configure a node (like a driver in an operating system).
PDO (Process Data Object)	CANopen frame containing I/O data. We distinguish between: Transmit-PDO (TPDO): data provided by a node Receive-PDO (RPDO): data to be consumed by a node The transmission direction is always seen from a node's point of view.
SDO (Service Data Object)	SDOs are typically used to read or write parameters while the application is running.
COB-ID (Communication Object Identifier)	Each CANopen frame starts with a COB-ID working as the Identifier. During the configuration phase, each node receives the COB-ID(s) for which it is the provider (or consumer).
NMT (Network Management Transition)	The NMT protocols are used to issue state machine change commands (i.e. to start and stop the devices), detect remote device boot ups and error conditions.



### USER MANUAL

#### TILTIX MEMS INCLINOMETER WITH CANOPEN INTERFACE

#### 5.1 Pre-Operational Mode

If the device is in this state, its configuration can be modified. However, only SDOs can be used to read or write device-related data. The device goes into Pre-Operational Mode:

- After the power up
- On receiving the Enter Pre-Operational NMT indication, if it was in Operational Mode before

If configuration is complete, the device goes into one of the following states on receiving the corresponding indication:

- "Stopped" on receiving the "Stop Remote Node" NMT indication
- "Operational" on receiving the "Start Remote Node" NMT indication

To set a node to pre-operational mode, the master must send the following message:

Identifier	Byte 0	Byte 1	Description
0 h	80 h	00	NMT-PreOp, All Nodes
0 h	80 h	NN	NMT-PreOp, NN

NN: Node Number

#### 5.2 Operational Mode

The device goes into the "Operational" state if it was in the "Pre-Operational" state on receiving the "Start Remote Node" indication. If the CANopen network is started using the "Node Start" NMT services in "Operational" state, all device functionalities can be used. Communication can use PDOs or SDOs.

**Note:** Modifications to the configuration in "Operational" mode may have unexpected consequences and should therefore only be made in "Pre-Operational" mode.

To put one or all nodes in "Operational" mode, the master has to send the following message:

Identifier	Byte 0	Byte 1	Description
0h	01h	00h	NMT-Start, all nodes
0h	01h	NN (in hex)	NMT-Start, NN

NN: Node Number

### USER MANUAL

#### TILTIX MEMS INCLINOMETER WITH CANOPEN INTERFACE

#### 5.3 Stopped Mode

The device goes into the "Stopped" mode on receiving the "Node Stop" indication (NMT service) if it was in "Pre-Operational" or "Operational" mode. In this mode, the device cannot be configured. No service is available to read and write device-related

data (SDO). Only the slave monitoring function "Node Guarding" remains active. To put one or all nodes in the "Stopped" mode, the master has to send the following message:

Identifier	Byte 0	Byte 1	Description
0 h	02 h	00h	NMT-Stop, all nodes
0 h	02 h	NN (in hex)	NMT-Stop, NN

NN: Node Number

#### 5.4 Re-Initialization of the Inclinator

If a node is not operating correctly, it is advisable to carry out a re-initialization. After re-initialization, the

inclinator accesses the bus in pre-operational mode.

Identifier	Byte 0	Byte 1	Description
0 h	82 h	00h	Reset Communication
0 h	81 h	NN (in hex)	Reset Node

Polled Mode	By a Remote Transmission Request Telegram, the connected host calls for the current process value. The inclinometer uses the current position value, calculates eventually set-parameters and sends back the obtained process value by the same identifier.
Cyclic Mode	The inclinometer transmits cyclically the current process value, without being called by the host. The cycle time can be programmed in milliseconds for values between 1 ms and 65536 ms.
Sync Mode	The inclinometer answers with current process value after receiving a sync telegram. The parameter sync counter can be programmed to skip a certain number of sync telegrams before answering again.
Heartbeat Function	A node signals its communication status by cyclically transmitting a heartbeat message. This message is received by one or any number of members (Heartbeat Consumers) in the bus and so they can control the dedicated node (Heartbeat Producer).

### USER MANUAL

#### TILTIX MEMS INCLINOMETER WITH CANOPEN INTERFACE

##### 5.5 Boot-up Procedure

The general boot-up procedure for the TILTIX CANopen and the mapping of various modes are illustrated below:

Number	Description
1	Module Power up
2	After initialization, the module automatically goes into pre-operational mode
3	NMT: Start Remote Node
4	NMT: Pre-operational Mode
5	NMT: Stop Remote Node
6	NMT: Reset Node
7	NMT: Reset Communication

##### 5.6 Usage of Layer Settings Service (LSS)

The integrated Layer Setting Services (LSS) functionality is designed according to the CiA normative DS305V200 CANopen Layer Setting Services. These services and protocols can be used to enquire or to change settings of several parameters (of the physical, data link, and application layer) on a CANopen device with LSS slave capability by a CANopen device with LSS master capability via the CAN network. In case of TILTIX, the TILTIX inclinometer will be the LSS slave device and the PLC (control) has to support LSS master device functionality. The LSS-functionality of the TILTIX series is limited to the following parameters of the application layer,

namely node number and baud rate. The LSS master device requests services that are performed by the inclinometer (LSS slave devices). The LSS master device requests the LSS address from the LSS slave device. The LSS address is defined in object 1018h Identity Object; it consists of vendor-id, product-code, revision-number and serial-number as shown in the table below. After receiving this information the control can identify the inclinometer, the node-number and baud rate can then be set. The exact procedure varies in detail, dependent on the utilized PLC tool. This object provides the general identification of the inclinometer.

Subindex	Description	Data Type	Default Value
0	Number of entries	Unsigned 8	0x4
1	Vendor Id	Unsigned 32	0x42
2	Product Code	Unsigned 32	0x43415032
3	Revision Number	Unsigned 32	0x00010500 <sup>1</sup>
4	Serial Number	Unsigned 32	–

1) Prone to change with every revision.

### USER MANUAL

#### TILTIX MEMS INCLINOMETER WITH CANOPEN INTERFACE

## 6 Installation

### 6.1 Accessories

Article No	Article	Description
TILTIX360/080	Inclinometer	TILTIX series of Inclinometers (Industrial / Heavy-Duty)
Download	Datasheet <sup>1</sup>	TILTIX Data Sheet, Specifications and Drawings
Download	User Manual <sup>1</sup>	Installation and Configuration User Manual (English)
Download	EDS-File <sup>1</sup>	Electronic Datasheet (EDS) File for Configuration
10001978	Connector	Female M12, 5pin A-coded Connector, w/ 2m PUR Shielded Cable
10012182	Connector	Female M12, 5pin A-coded Connector, w/ 5m PUR Shielded Cable
10005631	Termination Res	External terminal resistors for higher baud rate transmissions

1) The latest documentation and the EDS file can also be downloaded from our [website](#).

### 6.2 Pin Assignment

The inclinometer is connected via a 5-pin round sensor, Female at connector counterpart or M12 connector. (Standard M12, Male side at connection cable).

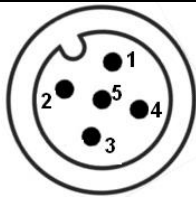
Signal	5 pin round connector	Cable Exit	Pin Assignment
CAN Ground	1	Green	
VS Supply Voltage	2	Red	
0 V Supply Voltage	3	Yellow	
CAN High	4	White	
CAN Low	5	Brown	

### 6.3 Installation Precautions



**Warning:** Do not remove or mount while the inclinometer is under power!



Avert any modifications to the housing!

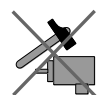

Avoid mechanical load!

Prior to installation, please check for all connections and mounting instructions to be complied with. Please also observe the general rules and regulations on operating low voltage technical devices, for safety and sustainability of TILTIX Inclinometers over long period of time.

Please read the installation leaflet for detailed instructions and precautions during mounting and installation.

### USER MANUAL

#### TILTIX MEMS INCLINOMETER WITH CANOPEN INTERFACE

#### 6.4 Mounting Instructions

TILTIX is a pre-calibrated device which can be put into immediate operation, upon simple and easy installation with a three point mount. The mounting surface must be plane and free of dust and grease. We recommend hex-head screws with M4 or UNC bolts #6 (TILTIX Industrial) and M6 or UNC bolts 1/4 (TILTIX Heavy-Duty) for the best possible and secure mounting.

Use all three screws for mounting but restrict the tightening torque in the range of 1.5 – 2.5 Nm for the

screws. The M12 connectors are to be perfectly aligned and screwed till the end with a tightening torque in the range of 0.4 – 0.6 Nm. Use all three screws for mounting and also note to use the same tightening torque for all the screws.

Prior to installation, please check for all connection and mounting instructions to be complied with. Please do also observe the general rules and regulations on low voltage technical devices.

#### 6.5 Bus Termination

If the inclinometer is connected at the end or beginning of the bus or is used at transmission  $\geq 50$  kBaud a termination resistor of 120 Ohm must be used in order to prevent reflection of information back into the CAN bus. TILTIX sensors have built-in termination resistors that can be activated (1) or deactivated (0) if required by setting object 3002h accordingly. Please refer to the Appendix A to learn more about the objects.

The bus wires can be routed in parallel or twisted, with or without shielding in accordance with the electromagnetic compatibility requirements. A single line structure minimizes reflection.

The following diagram shows the components for the physical layer of a two-wire CAN bus:

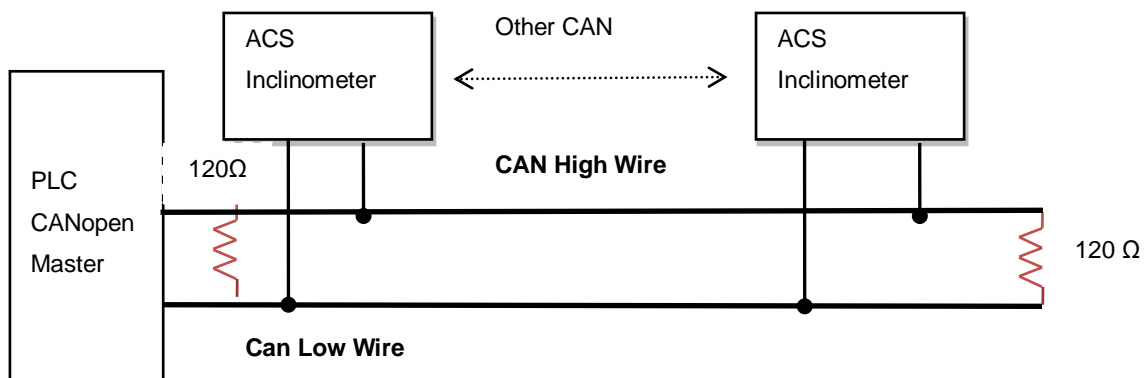

### USER MANUAL

### TILTIX MEMS INCLINOMETER WITH CANOPEN INTERFACE

#### 6.6 LED Definition

<b>Status LED (Duo colored) Green / Red LED</b>	<b>Meaning</b>
Green off	No power supply
Green flashing	Device in CAN state STOPPED.
Green blinking	Boot Up message sent, device configuration is possible Device in CAN state PRE-OPERATIONAL
Green on	Normal operation mode, Encoder in CAN state OPERATIONAL
Red off	Normal operating mode
Red single flash	At least one of the error counters of the CAN controller has reached or exceeded the warning level (too many error frames)
Red double flash	A guard event or heartbeat event has occurred
Red on	The can controller is in state bus off. No communication possible anymore. Too many error frames in the network.
Red / Green flickering	Auto Baud Mode is active and the encoder tries to find within the Time out period a valid CAN message for baud rate measurement

## USER MANUAL TILTIX MEMS INCLINOMETER WITH CANOPEN INTERFACE

### 6.7 Measurement Axes

#### TILTIX 80 – Dual Axis Inclinerometer

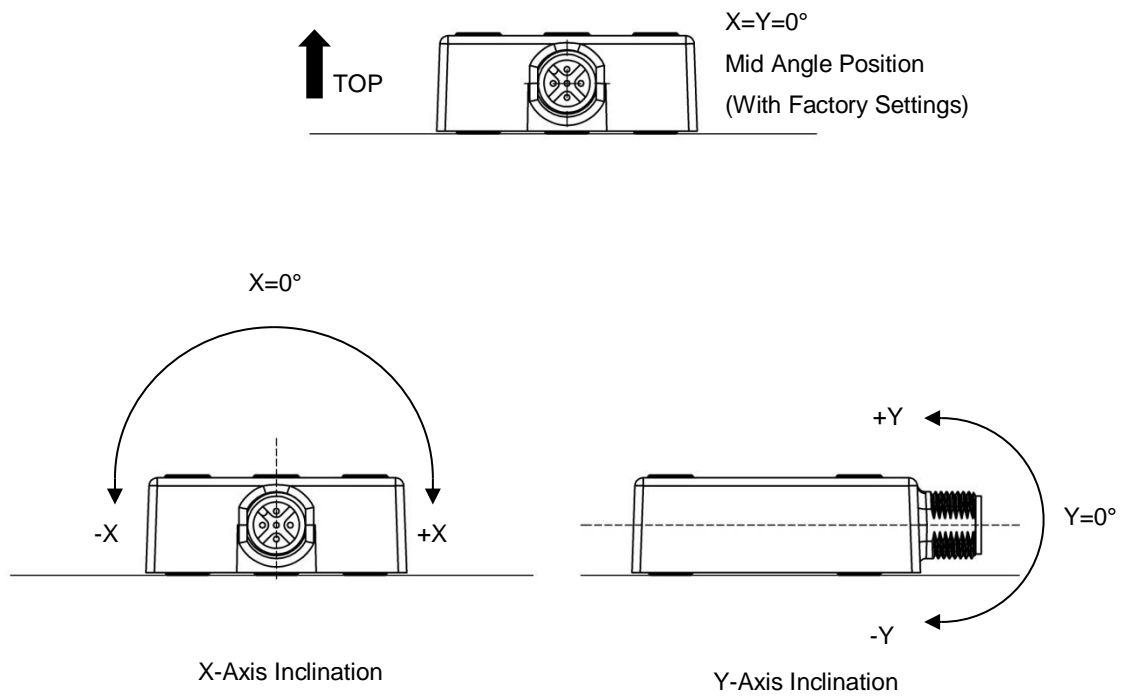

#### TILTIX360 – Single Axis Inclinerometer

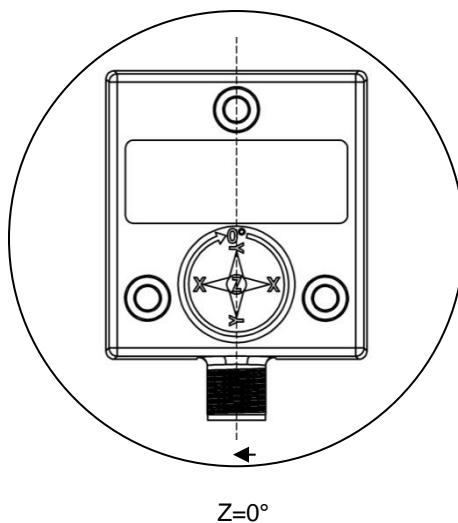

Initial Starting Point (Factory Settings)

### USER MANUAL

#### TILTIX MEMS INCLINOMETER WITH CANOPEN INTERFACE

## 7 TILTIX Software Configuration

This chapter succeeds the hardware configuration as in real time. TILTIX is a very flexible device and hence all the parameters are programmable via CAN bus. This enables remote configuration.

This chapter is divided into two major parts - one describing the methodology for putting the TILTIX into operation and the other for PDO/SDO programming of TILTIX.

### 7.1 Default Factory Settings

Description	Object	Value
Device Type	1000h	0x4019A (2-Axis) 0 x 3019A (1 Axis)
Cyclic Timer	2200h	00h (0 ms)
Resolution	6000h	0Ah (0.01°)
Node Number	3000h	00h (Node number: 1)
Baud Rate	3001h	03h (125 kB)

**Note:** The factory settings can be restored at any time. Few of the parameters have to be re-programmed in order to make the TILTIX

inclinometers compatible with the controller or the already existing CAN bus to which it is going to be installed on.

### 7.2 Active Programming Objects

Active CANOpen objects depending on the state of TILTIX: The crosses in the table below indicate

which CANOpen objects are active in each state.

Initialization	Pre-Operational	Operational	Stopped	
PDO Object			x	
SDO Object		x	x	
Boot-Up	x		x	
NMT		x	x	x



### USER MANUAL

#### TILTIX MEMS INCLINOMETER WITH CANOPEN INTERFACE

#### 7.3 Programmable Parameters

Objects are based on the CiA-DS410 CANopen profile for inclinometer ([www.can-cia.org](http://www.can-cia.org)). The following table gives a list of the command identifiers sent and received by the inclinometer. These are the standard commands used for

communication and transmission between a master and slave in a CAN bus. It is quite useful for the analysis of communication logs between the master and slave and for better understanding of the system under observation.

#### 7.4 Command Description

Command	Function	Telegram	Description
22h	Domain Download	Request	Parameter to TILTIX
60h	Domain Download	Confirmation	Parameter Received
40h	Domain Upload	Request	Parameter Request
43h, 4Bh, 4Fh 1	Domain Upload	Reply	Parameter to Master
80 h	Warning	Reply	Transmission Error

1) The value of the command byte depends on the data length of the called parameter.

#### 7.5 Data Length of Commands

Command	Data length	Data Length
43h	4 Byte	Unsigned 32
4Bh	2 Byte	Unsigned 16
4Fh	1 Byte	Unsigned 8

### USER MANUAL

#### TILTIX MEMS INCLINOMETER WITH CANOPEN INTERFACE

#### 7.6 Frequently Used Commands

The following list shows the most frequently used objects while programming the TILTIX inclinometer. The whole list of objects is provided in Appendix A.

Section 6 offers important programming tips and FAQ which are necessary for the proper use of the inclinometer.

Position Value (Objects 6010h, 6020h)	The objects 6010h and 6020h are used to get the scaled inclination positions (integer 16 variables) of TILTIX080 in the range of $\pm 80^\circ$ and the object 6010h is used to get the scaled inclination position of TILTIX360 in the range of 0 – 359.99°.
Store Parameters (Objects 1010h, 2300h)	Object 1010h is used to store either all parameters or only parts of the object dictionary if necessary. Whereas, object 2300h stores and saves all current parameters with an additional NMT reset of the TILTIX.
Resolution in Degree (°) (Object 6000h)	This parameter is used to program the desired resolution based on 0.001°. The resolution can be set to 1° (1000d), 0.1° (100d) or 0.01° (10d). (Default 10d – 0.01°)
Preset Value (Objects 6012h/6022h)	The Preset Value is the desired position value (for example 0°), which should be reached at a certain physical position of the measurement axis. The position value is set to the desired process value by the parameter Preset. TILTIX080 uses Object 6012h for X-Axis and Object 6013h for Y-Axis. TILTIX360 uses Object 6012h for the Z-Axis.
Baud Rate (Object 3001h)	The Baud rate can be programmed via SDO. (Default 125 kBaud)
Node Number (Object 3000h)	The setting of the Node Number can be achieved via SDO-Object. Valid addresses range from 1 to 127, each address can only be used once. The value set in this object is incremented by one to prevent setting the Node Number 0. For inclinometers programmed via SDO, the default is 0h = Node Number 1
Filters (Objects 3100h/3022h)	The filter is a routine to process the data stream of the base sensor. It can be used to adjust the averaging or weighting of measurements and calculation of position values. <ul style="list-style-type: none"> <li>- Object 3100h corresponds to moving average filter</li> <li>- Object 3022h is for the digital recursive filter</li> </ul> Default: Object 3100h: 100, Object 3022h: 0.

### USER MANUAL

#### TILTIX MEMS INCLINOMETER WITH CANOPEN INTERFACE

#### 7.7 PDO Transmission

Process Data Objects (PDOs) communicate process information/data and enable them to be exchanged in real time. A CANopen device's PDO set describes the implicit exchanges between this device and its communication partners on the network. The exchange of PDOs is only authorized if the device is in "Operational" mode.

Note: The PDOs can be directly mapped into memory locations on the controller and can be viewed upon reading those memory locations. An example with a SCHNEIDER-TWIDO controller is provided in the next section.

#### 7.8 Object 1800h: 1st Transmit PDO Communication Parameter

This object contains the communication parameter of the 1st transmit PDO.

Subindex1	Description	Data Type	Default Value	Access	Restore after BootUp
00h	Number of sub indices	Unsigned 8	5	ro	yes
01h	COB-ID	Unsigned 32	180h + Node ID	rw	yes
02h	Transmission Mode	Unsigned 8	1	rw	yes
03h	Inhibit Time	Unsigned 32	0	rw	yes
04h	Not Available				
05h	Event Timer	Unsigned 32	0	rw	yes

1) Subindex: Second degree identifier used in combination with the object. (Follows the object number)

### USER MANUAL

#### TILTIX MEMS INCLINOMETER WITH CANOPEN INTERFACE

#### 7.9 Object 1801h: 2nd Transmit PDO Communication Parameter

This object contains the communication parameter of the 2nd transmit PDO.

Subindex1	Description	Data Type	Default Value	Access	Restore after BootUp
00h	Number of sub indices	Unsigned 8	5	ro	yes
01h	COB-ID	Unsigned 32	280h + Node ID	rw	yes
02h	Transmission Mode	Unsigned 8	254	rw	yes
03h	Inhibit Time	Unsigned 32	0	rw	yes
04h	Not Available				
05h	Event Timer	Unsigned 32	0	rw	yes

1) Subindex: Second degree identifier used in combination with the object. (Follows the object number)

#### 7.10 Transmission Mode

The transmission mode (Sub index 2) for Objects 1800 and 1801 can be configured as described below:

Transfer Value (Dec)	Transmission Mode					Note
	Cyclic	Acyclic	Synchronous	Asynchronous	RTR Only	
0	X	X				Send PDO on first sync message following an event
1 – 240	X	x				Send PDO every x sync messages
241 – 251	Reserved					
252			X		X	Receive Sync and send PDO on remote request
253					X	Update data and send PDO on remote request
254				x		Send PDO on event
255				x		Send PDO on Event

### USER MANUAL

#### TILTIX MEMS INCLINOMETER WITH CANOPEN INTERFACE

##### 7.11 Inhibit Time

The inhibit time is the minimum interval for PDO transmission if the transmission type is set to 254d (FEh) and 255d (FFh). The value is defined as

multiple of 100  $\mu$ s. The Inhibit Time cannot be changed while the respective PDO is in operation.

##### 7.12 Event Timer

The Event Timer only works in asynchronous transmission mode (transmission mode 254d and 255d). The value is defined as multiple of 1 ms. A transmit PDO is sent after the Event Timer expires

(for values > 0). The range is 1 – 65536 ms. The Event Timers of TPDO1 and TPDO2 are hardwired, i.e. if one timer is changed, the other one is adjusted accordingly.

##### 7.13 Cyclic Timer

The Cyclic Timer is hardwired with both Event Timers of TPDO1 and TPDO2. Due to the fact that it is possible to save either communication parameters (Event Timers) or manufacturer parameter (Cyclic Time), the parameters could hold

different values after a power off/on cycle. The inclinometer prevents this mismatch by checking these values during startup. The event timer value is copied to the Cyclic Time if they do not match.

### USER MANUAL

#### TILTIX MEMS INCLINOMETER WITH CANOPEN INTERFACE

#### 7.14 Object 1A00h: 1st Transmit PDO Mapping Parameter

This object contains the mapping parameter of the 1st transmit PDO.

Subindex	Description	Data Type	Default Value	Access	Restore after BootUp
0	Number of sub indices	Unsigned 8	80°-2 (± 80°) 360°-1 (360°)	ro	yes
1	Mapped object	Unsigned 32	0x60100010	rw	yes
2	Mapped object	Unsigned 32	0x60200010	rw	yes

#### 7.15 Object 1A01h: 2nd Transmit PDO Mapping Parameter

This object contains the mapping parameter of the 2nd transmit PDO.

Subindex	Description	Data Type	Default Value	Access	Restore after BootUp
0	Number of sub indices	Unsigned 8	80°- 2, 360°-1	ro	yes
1	Mapped object	Unsigned 32	0x60100010	rw	yes
2	Mapped object	Unsigned 32	0x60200010	rw	yes

#### 7.16 Types of SDO

Service Data Objects (SDOs) allow a device's data to be accessed by using explicit requests. The SDO service is available if the device is in the "Operational" or "Pre-Operational" state. There are two types of SDOs:

- Read SDOs (Download SDOs)
- Write SDOs (Upload SDOs).

The SDO protocol is based on a 'Client/Server' model:

Download SDO	The client sends a request indicating the object to be read. The server returns the data contained within the object.
Upload SDO	The client sends a request indicating the object to be written to with the desired value. After the object has been updated, the server returns a confirmation message.
Unprocessed SDO	The server returns an error code (80) in both cases if an SDO could not be processed.

### USER MANUAL

### TILTIX MEMS INCLINOMETER WITH CANOPEN INTERFACE

Atypical illustration of an SDO for explicitly reading the current baud rate value is given below:

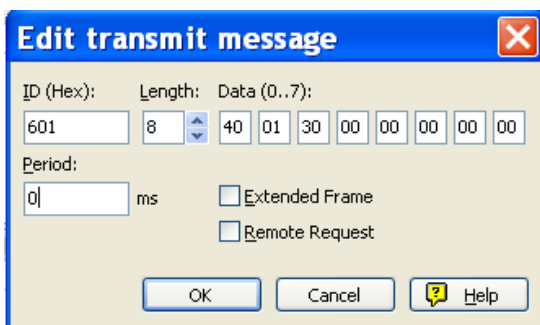

SDO passed as a new message to the device

We used a PEAK™ CAN master for this illustration. The PCAN®-USB adapter enables simple connection to CAN networks.

The PCAN®-USB's compact plastic casing makes it suitable for mobile applications. It works as a master on the CAN bus connection via D-Sub, 9-pin and is in accordance with CiA102 standards. (To learn more about Peak CAN click here)

- Object 3001h allows to read the baud rate value from the inclinometer.
- Transmit Message
- ID: 601- Message to NN1
- Length: 8bit word
- Data 0: Read (40) / Write (22)
- Data 1 & 2 : Object in Big Endian (3001s is 0130 in Big Endian format)
- Data 3: Sub-Index (NA)
- Data 4-7: Data to be written (NA in read command)
- The Received message 581h
- reads out the data

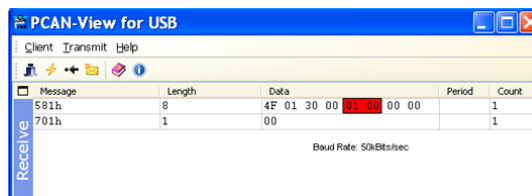

Received Message from the Device

So, SDOs can be used to explicitly read or write data in TILTIX CANopen inclinometers. All the relevant objects that can be configured are described in Appendix A.

In the above example, 701h is the boot up message received. Then once we transmit the SDO command as shown above, we receive a reply. The received message 581h, consists of the domain downloaded. In this case it is the baud rate (01h – 50 kB) as indicated in the above figure.

### USER MANUAL

#### TILTIX MEMS INCLINOMETER WITH CANOPEN INTERFACE

## 8 Working with Schneider PLC

### 8.1 Types of SDO

An TILTIX360, single axis inclinometer was connected to a TWIDO programmable logic controller with a CANopen communication interface. The step-by-step connection procedure and the working of the inclinometer in a CAN bus is illustrated in the following sections. Please note that, the

programming in other control systems may vary individually. Please have this section as a reference for TILTIX' working with programmable logic controllers.

### 8.2 Types of SDO

An TILTIX360, single axis inclinometer was connected to a TWIDO programmable logic controller with a CANopen communication interface.

that, the programming in other control systems may vary individually. Please have this section as a reference for TILTIX' working with programmable logic controllers.

The step-by-step connection procedure and the working of the inclinometer in a CAN bus is illustrated in the following sections. Please note

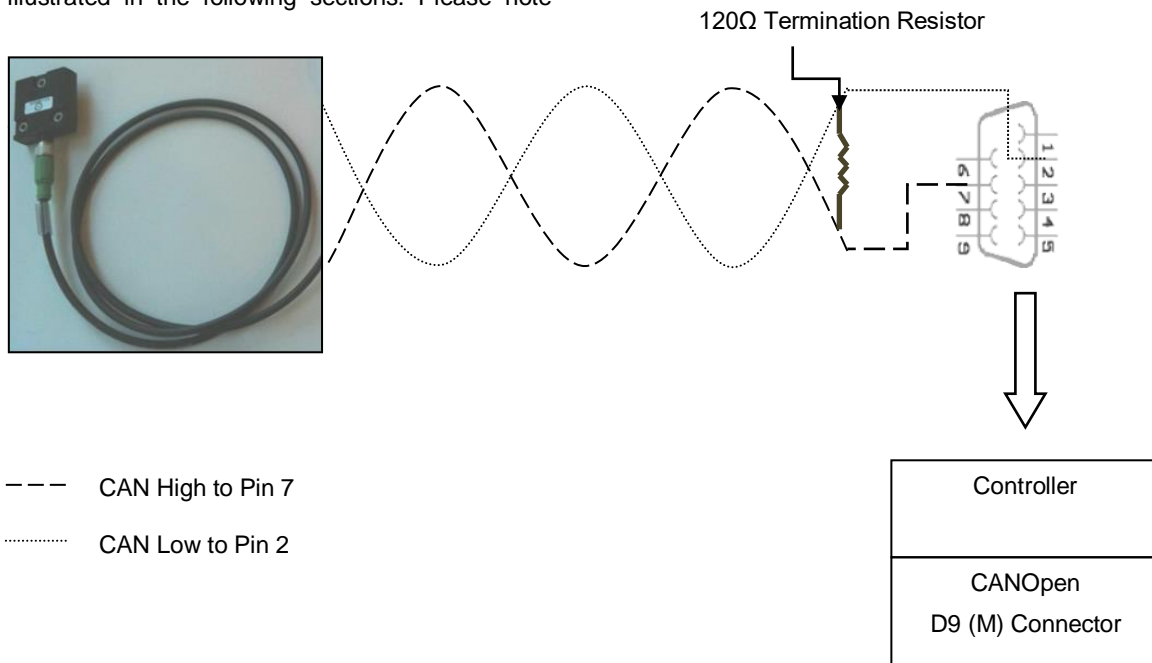



### USER MANUAL

#### TILTIX MEMS INCLINOMETER WITH CANOPEN INTERFACE

#### 8.4 Software Project Information

Once the hardware setup is done the TILTIX should be configured in such a way that it is compatible to the already existing setup and gives a proper position output.

**Project information**

**File information**

Project:

Directory:

---

**Project information**

Author:

Department:

Index:

Industrial Property:

Comment | Description | Image

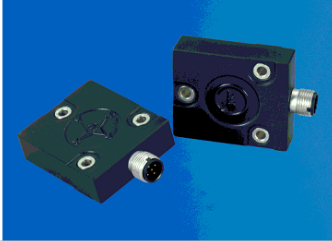

#### TWDLMDA20DTK

Modular base controller, 12 24V DC inputs, 8 outputs (0.3A source transistors). Removable MIL connectors.

#### 8.5 Controller Description

**Description of the module**

Reference number:  Address:

Description: Modular base controller, 12 24V DC inputs, 8 outputs (0.3A source transistors). Removable MIL connectors.

#### 8.6 CANopen Master Configuration

**Description of the module**

Reference number:  Address:

Description: CANopen bus master module.

#### TWDNCO1M

CANopen bus master module.



#### FRABA (V1.1)

Vendor: FRABA Posital GmbH  
 Description: EDS for ACS inclinometer (option 360°)  
 Author: FRABA Posital GmbH, Mr. Jakschies  
 Creation: 06-29-2004



### USER MANUAL

### TILTIX MEMS INCLINOMETER WITH CANOPEN INTERFACE

Once the TILTIX EDS file is being uploaded all objects – including the PDOs – are added to the controller. The Schneider system automatically

identifies the PDOs and maps them on to the slave device.

#### 8.7 Connection Network Setup

The illustration below, describes the connection of the elements in the CAN bus. At first, the CANopen communication interface is connected to the main

controller. Then the inclinometer is connected to the CANopen communication interface.

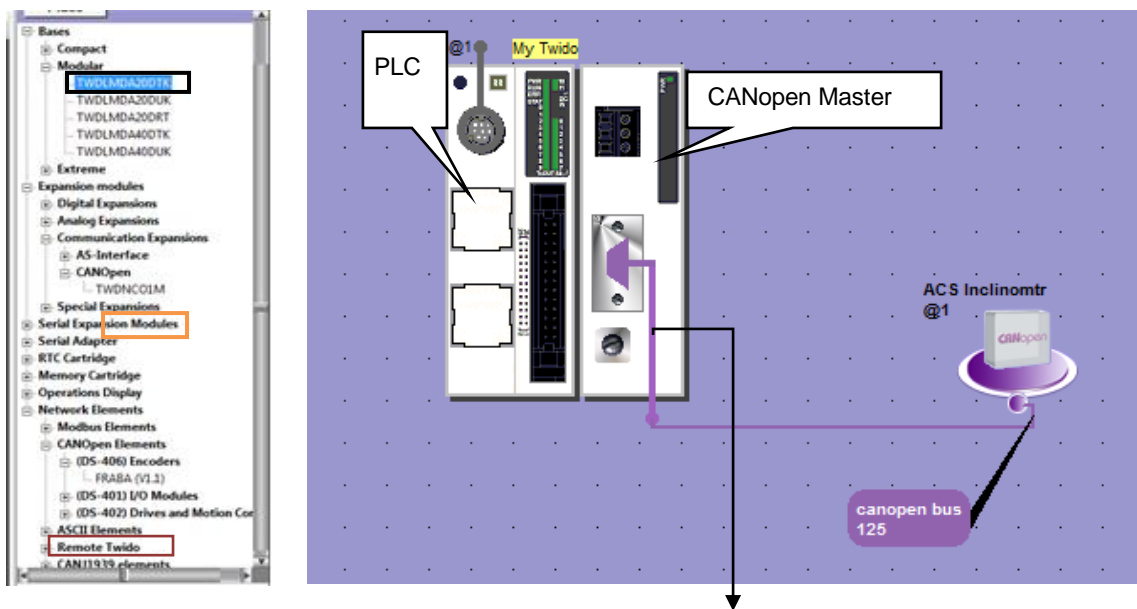

Linking of Master and Slave

The next step after the setup of the network is the configuration of all the parameters and settings, to facilitate the communication between the master, slave and the controller. This picture is the overall

description of the setup, with the TWIDO TWDLMDA20DTK controller, TWDNCO1M CANopen communication expansion module and the TILTIX360 EDS file.

### USER MANUAL

### TILTIX MEMS INCLINOMETER WITH CANOPEN INTERFACE

## 9 Configuration

### 9.1 TILTIX Process Data Objects (PDO)

#### Mapping

A list of all available objects is pre-programmed in the EDS file. Select the TILTIX inclinometer on the bus and click on Configuration. A list of all the mapped PDOs appears.

Then, according to need, the objects are mapped on to the Transmit-PDO's of the TILTIX.

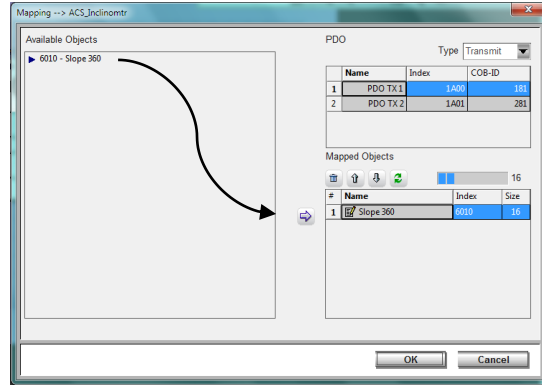

### 9.2 TILTIX CANopen Node Configuration

Click on the TILTIX inclinometer on the bus and select the CANopen configuration option. It is used to define the name, type, address and supervision of the node. Make sure the node number and the address coincide for the inclinometer selected.

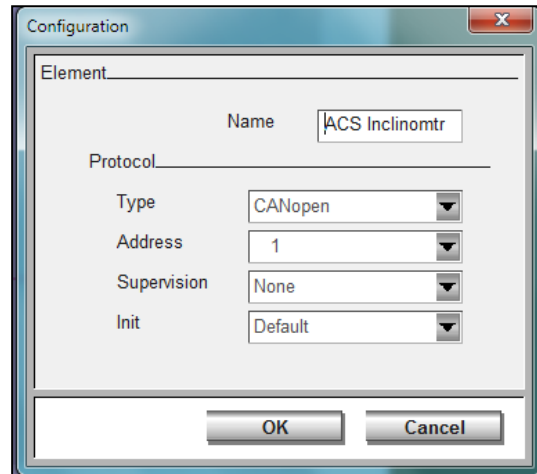

### 9.3 CANopen bus network configuration

Click on the bus connecting the TILTIX inclinometer and the PLC. Select the bus configuration option to define the name of the bus, the transmission speed and supervision time. Make sure that the TILTIX is configured with the appropriate baud. (All devices on the bus must have the same baud rate)

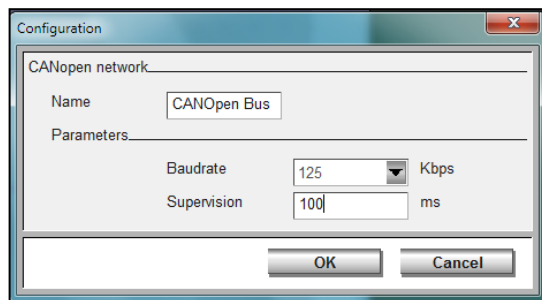

### USER MANUAL

#### TILTIX MEMS INCLINOMETER WITH CANOPEN INTERFACE

#### 9.4 Linking of CANOpen Master and TILTIX Transmit-PDOs

Select the CANopen link on the controller. Click on the configuration option. The PDOs of the slave are mapped on to the CANOpen master so that the information contained in the objects of the slave are transmitted and saved on to the controller's memory

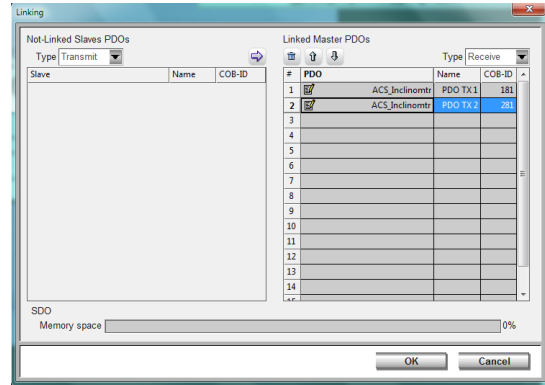

#### 9.5 TILTIX & Controller Memory Configuration

The current and updated position values from the TILTIX encoder are mapped on to an EEPROM memory location in the controller. This memory location, in this case %IWC1.0.0 and %IWC1.1.0

will always contain the slope values obtained from the object 6010h of the TILTIX when the controller is online.

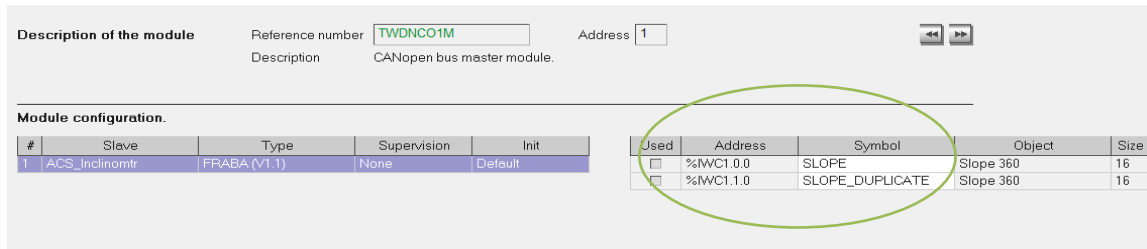

#### 9.6 Debugging

The debugging stage is done on completing the configuration of the PDO's. It involves the following steps:

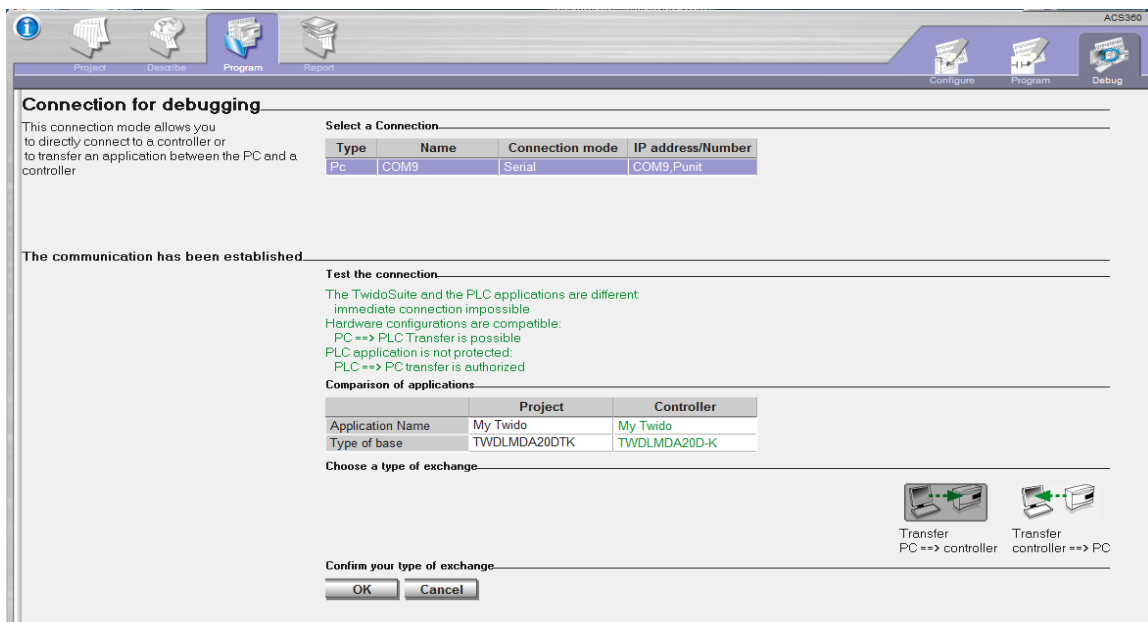

### USER MANUAL

### TILTIX MEMS INCLINOMETER WITH CANOPEN INTERFACE

The serial communication port is selected and PC → controller transfer is initiated. Once the transfer is initiated the configured parameters and the programming done on the PC is debugged and

transferred to the controller for real time application. The following illustrations are the intermediate tasks during debugging.

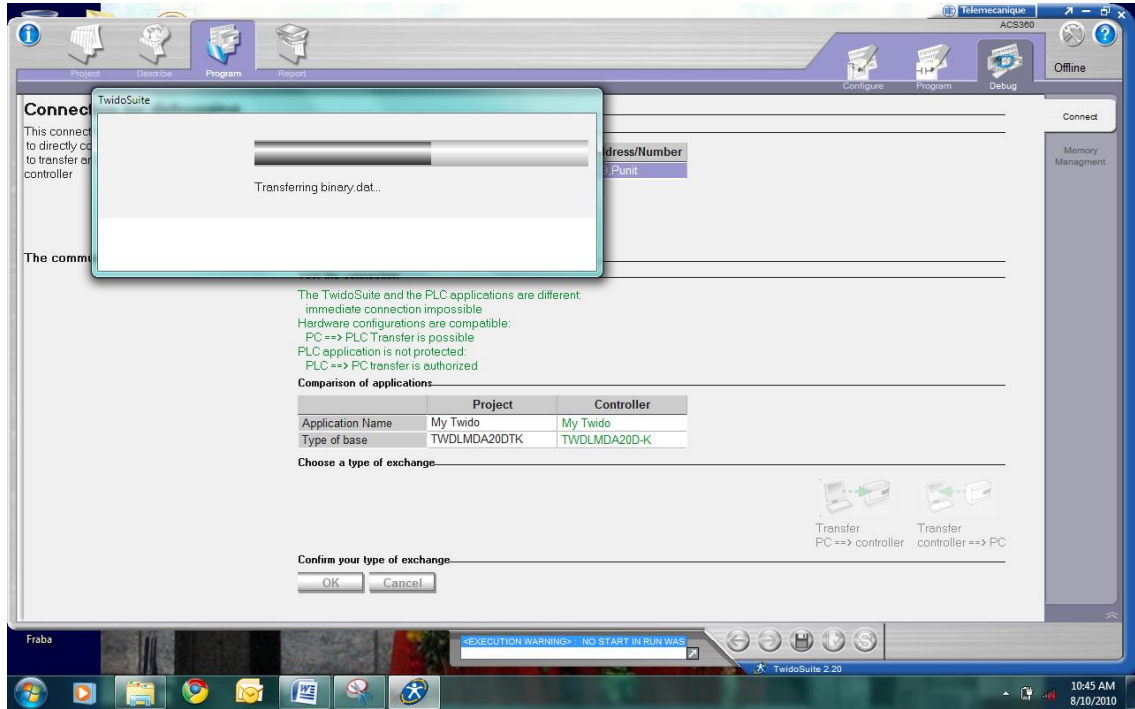

Converting all the configured parameters to binary formats.

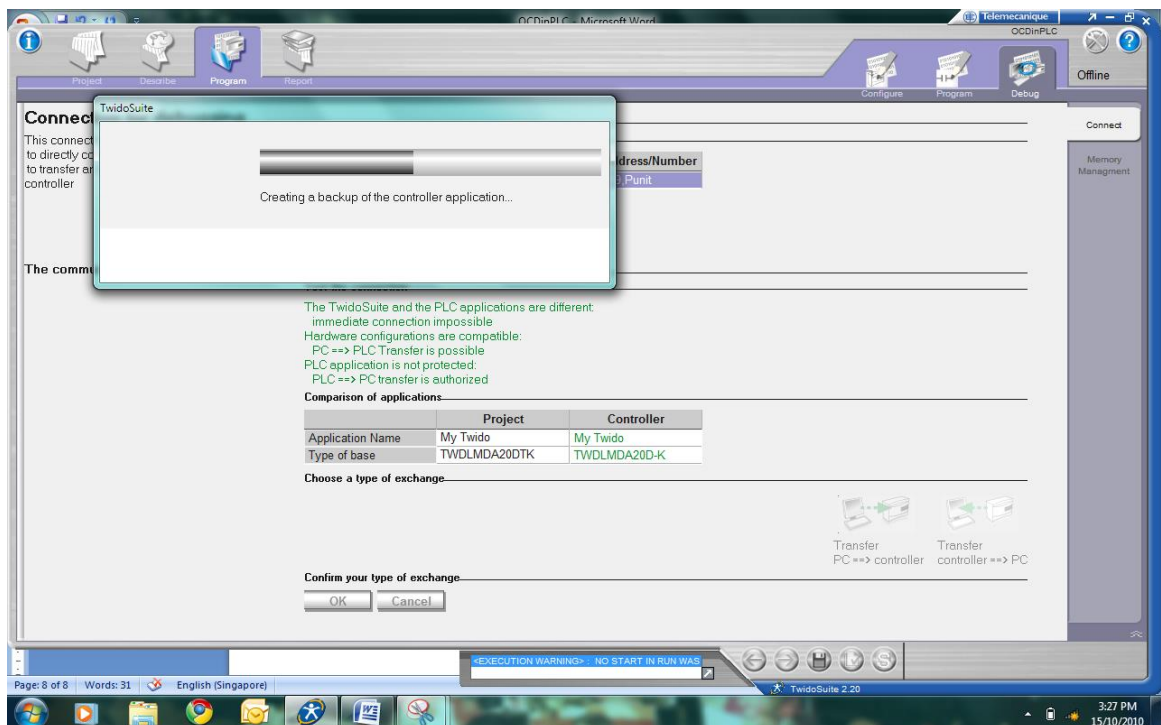

### USER MANUAL

### TILTIX MEMS INCLINOMETER WITH CANOPEN INTERFACE

Once the controller goes into the online mode, the PDOs cannot be changed. However, SDOs still can be configured if necessary.

#### 9.7 Run

Once debugged, the controller goes into online mode. SDOs then can be configured if needed before running the controller.

Upon start up, we can create an animation table to monitor the necessary controller parameters and the system variables which contain the position value. Now, we will program the PLC in order to obtain the position values.

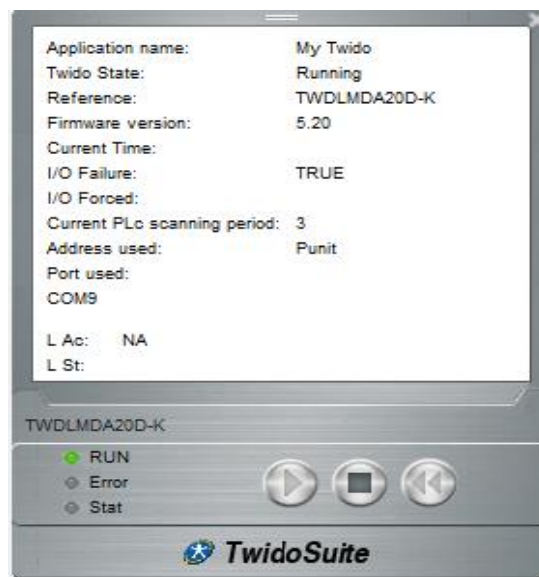

#### 9.8 Resetting CANOpen Communication

```

0 * LD 1
1 1/* [ %MW0 := 16#0001 ]
2 0/* [ %MW1 := 16#0000 ]
3 1 LD %SW81:X3
4 * /* [ CAN_CMD1 %MW0:2 ]
5 0 LDN %SW81:X4

```

#### 9.9 Resetting CANOpen Nodes

```

0 * LD 1
1 1/* [ %MW0 := 16#0001 ]
2 1/* [ %MW1 := 16#0001 ]
3 1 LD %SW81:X3
4 * /* [ CAN_CMD1 %MW0:2 ]
5 0 LDN %SW81:X4

```

```

0 * LD 1
1 2/* [ %MW0 := 16#0002 ]
2 1/* [ %MW1 := 16#0001 ]
3 1 LD %SW81:X3
4 * /* [ CAN_CMD1 %MW0:2 ]
5 0 LDN %SW81:X4

```

# POSITAL

## FRABA

### USER MANUAL

### TILTIX MEMS INCLINOMETER WITH CANOPEN INTERFACE

#### 9.10 Position Readout

```
0 * LD 1
1 3/* [ %MW0 := 16#0003 ]
2 1/* [ %MW1 := 16#0001 ]
3 24592/* [ %MW2 := 16#6010 ]
4 0/* [ %MW3 := 16#0000 ]
5 18416/* [ %MW4 := 16#0000 ]
6 0/* [ %MW5 := 16#0000 ]
7 * /* [ CAN_CMD1 %MW0:6 ]
```

Position Value

#### 9.11 Readout Using Animation Table

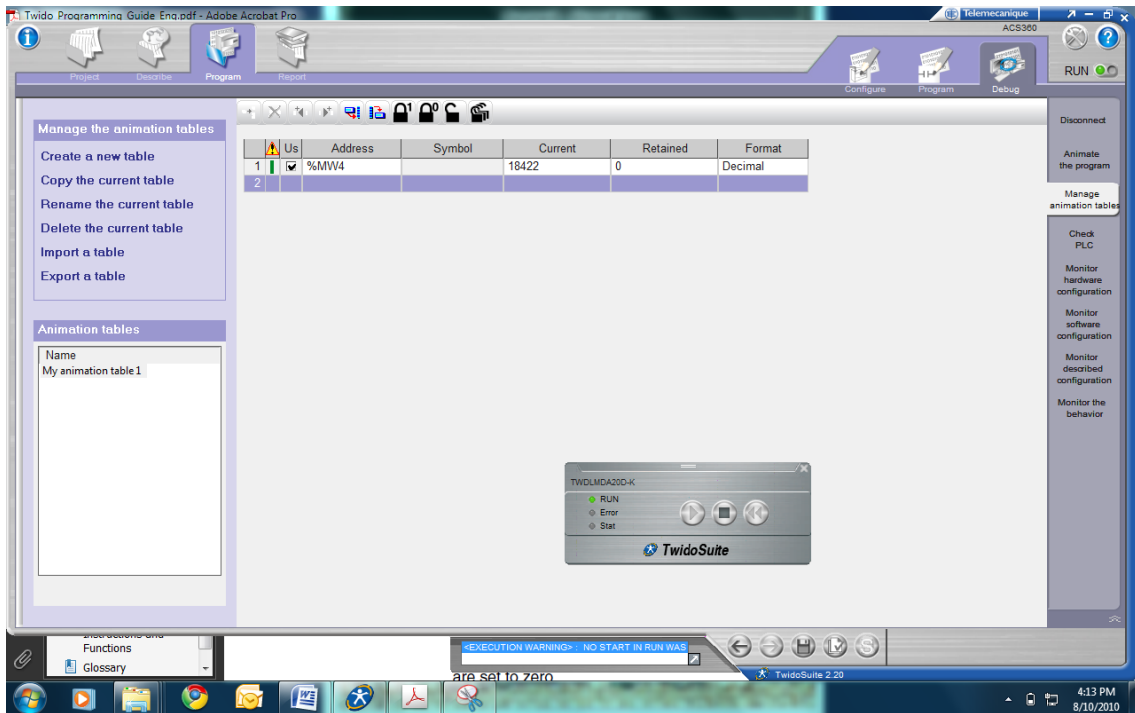

The position Readout is 18422 through the memory location %MW4 (Shown in the programming). We know that the resolution is set to 0.01°. TILTIX Position Value = 18422 x 0.01° = 184.22°

### USER MANUAL

#### TILTIX MEMS INCLINOMETER WITH CANOPEN INTERFACE

**Illustration of measurement over full range:** At initial position (approximately 0°):

	 Us	Address	Symbol	Current	Retained	Format
1	<input checked="" type="checkbox"/>	%MW4		32	0	Decimal
2						

**TILTIX Position Value = 32 \* 0.01° = 0.32°**

At approximately 90°:

	 Us	Address	Symbol	Current	Retained	Format
1	<input checked="" type="checkbox"/>	%MW4		9138	0	Decimal
2						

**TILTIX Position Value = 9138 \* 0.01° = 91.38°**

At approximately 180°:

	 Us	Address	Symbol	Current	Retained	Format
1	<input checked="" type="checkbox"/>	%MW4		18052	0	Decimal
2						

**TILTIX Position Value = 18052 \* 0.01° = 180.52°**

At approximately 270°:

	 Us	Address	Symbol	Current	Retained	Format
1	<input checked="" type="checkbox"/>	%MW4		27256	0	Decimal
2						

**TILTIX Position Value = 27256 \* 0.01° = 272.56°**

All the above position values were obtained by programming the position value output explicitly. The other method is very simple and direct.

Just run the controller and the same position values are obtained. The position is mapped with the

memory location %IWC1.0.0 or %IWC1.1.0 through PDO mapping done in the earlier steps. The steps for the mapping have been illustrated in above parts so that, in real time application, end users can directly follow the above steps to read out the position values from the mapped memory locations.



### USER MANUAL

### TILTIX MEMS INCLINOMETER WITH CANOPEN INTERFACE

## 10 Frequently Asked Question

### **What if the inclinometer doesn't respond after power on?**

If the bus is active, then, the installed inclinometer is transmitting a false node number. If the bus is inactive, then, it was connected with an incorrect baud rate.??

Possible solution may include addressing the node in pre-operational mode, addressing the inclinometer via SDO, trying to reset or power off or reprogramming the baud rate.

### **How to avoid malfunction of the position value during transmission?**

During the transmission of the position value occasional malfunctions can occur. The CAN bus can be temporarily in the bus off state, too.

In order to avoid this problem, please check if the last bus nodes have the terminal resistor. The termination resistors at the ends of the CAN bus are generally used to avoid the reflection of information back into the bus. If the last bus node is an TILTIX Inclinometer the terminal resistor is to be activated through object 3002h.

### **When can too many ERROR-Frames appear?**

The bus load maybe too high in case of too many error frames. So in this case check if all bus nodes have the same baud rate. Even if one node has a different baud rate, error frames are produced automatically.

Always ensure that the baud rate is set according to the defined TILTIX Baud rate table and once the baud rate has been changed the can bus has to be restarted with the communication changed to the recently set baud rate??.

### **What does Unexpected module / Module missing / Wrong Module errors refer to?**

Improper definition of node address or improper loading of EDS file generally leads to such errors. It is best to reinitialize the CAN bus or re-install the EDS file.

The node state stopped upon loading and initialization!

It occurs mostly because the bus transmission timeout is defined shorter than the TILTIX transmission time. So it is best to increase the bus timeout period (Approximately 2 – 3 seconds).

### **Unable to change to another node number?**

If all nodes are found to be in operational mode, then follow the next few steps to set the required node number to a selected device.

Calculate the required node number in hexadecimal. (TILTIX is internally programmed to add 1 to any node number change fed to it, in order to avoid the node number 0; Range of Node Numbers: 1 – 127). For example if we want a NN=28 decimal, we need to feed 27 decimal (27+1=28). So the NN 1B hex has to be fed in order to set the selected device to node number 28.

Send a write telegram to the particular node, with 1B as data on the object 3000h.

Use 2300h to save the parameters with the reset.

A boot up message with the new node number pops us.

### USER MANUAL

### TILTIX MEMS INCLINOMETER WITH CANOPEN INTERFACE

#### What is the significance of boot-up message?

```
Rx      0701  1  00
```

The boot up message signifies that the node is active and can communicate. The node number can be identified from the boot-up message.

NN = 701h – 700h = 1h = 1

#### What is the difference between operational and pre-operational mode?

The main difference between the modes is that in pre-operational mode only service data objects (SDOs) can be programmed whereas in operational mode all device functionalities SDOs, PDOs can be programmed.

Modification of parameters in the operational mode may sometimes have unexpected consequences and should therefore be avoided.

#### How to read position value?

Send a message to the TILTIX to read out the position data object (6010h/6020h). The current position is calculated and is given out as a reply to the above message.

For example, the position data is given out as 0EF8 hex, this is 3832 in decimal. If the resolution is 0Ahex (0.01°) then the position value is (position output in decimal X Resolution), 3832 X 0.01° = 38.32°.

#### Why are there different types of storing and re-storing?

Object 2300h can be used to save all the parameters in the non-volatile memory at once. But when we use object 1010h for storing and object 1011h for re-storing there are a lot of options available – Communication, Application, Manufacturer or all parameters. It enables the user to store specific types of objects without disturbing

the other configurations. Hence, this gives the user ease and flexibility for storing only particular objects.

#### How to send sync message?

A sync message can be sent using COB-ID Sync object – 1005h. The default COB-Id value is 0 x 80. Upon receiving a message with the COB-ID and sync object, the TILTIX TPDO replies with the current position value. A general sync telegram will have the following parameters:

- COB-ID 080 (Default)
- Data Bits 8
- Read/Write Read (40)
- Object 1005
- Sub-Index 0
- Data Bits None

#### How to set the cyclic timer?

The cyclic timer can be set with the object 2200h. Write the required cycle time in ms (0 -65536) to the object and save the parameters.

The cyclic timer is hardwired to the TPDO event timers to avoid conflicts. The TPDO timers are given higher priority. Hence, upon boot up, if the cyclic timer and event timers have different values, the TILTIX immediately writes the value of the event timers to the cyclic timer to make it uniform.

#### How to configure PDO Transmission?

The position value can be transmitted in various modes using PDO objects. The modes can be configured according to the user's requirement.

- Sync Mode  
This mode allows the user to receive the position value only if requested. Change the transmission type of the corresponding TPDO communication object (1800h/1801h) to sync mode by writing 1HEX to sub-index 2.

Once back in operational mode, the user

needs to transmit a sync message when a position value is required. The TILTIX replies with current position value through the TPDO COB-ID (Default: 0x181 for TPDO 1 & 0x281 for TPDO 2).

#### - Cyclic Mode

This mode allows the user to receive the position values at a constant interval.

Change the transmission type of the corresponding TPDO communication object (1800h/1801h) to cyclic mode by writing 254

(FE Hex) to sub-index 2. Make sure that the cyclic timer is set to the value of the required interval.

Once in operational mode, the TILTIX shall start transmitting the position output at a constant interval, with the TPDO COB-ID (Default: 0x181 for TPDO 1 & 0x281 for TPDO 2).

#### - State Change Mode

This mode enables the user to receive position data only when there is a change in its value.

Change the transmission type of the corresponding TPDO communication object (1800h/1801h) to state change mode by writing 255 (FF Hex) to sub-index 2. Make sure that the inhibit timer is also set as required.

Once in operational mode the TILTIX outputs the position only if there is a change in its value.

#### How to calculate the inhibit time?

The inhibit time sets the minimum time between two process values. The value is defined as multiples of 100µs. For example, assume we set the inhibit timer (Object 1800h/1801h) sub-index 3 to 1000d (03E8hex). The inhibit time is set to 100ms (1000 x 100µs) it is not allowed to change the inhibit time while the PDO exists.

#### Unable to set preset?

While setting preset there are a few considerations like resolution and range that have to be taken into consideration. The resolution of the TILTIX set by the user defines the range of the values that can be set. Hence, while setting the preset the user has to be careful to be within range.

#### What is a moving average filter?

The moving average filter is a kind of simple low pass filter. In TILTIX the moving average is used to dampen the effects due to external influences like vibrations. 0 means that the filter is deactivated. The user can define the array size in the range of 1-250 (decimal). Once the array size is defined the TILTIX takes an average of the position data array for the final position output.

#### Why use digital recursive filter?

The digital recursive filter is an impulse response filter. In TILTIX the digital recursive filter is used to smoothen the position output in case of highly varying position data. This is achieved using the proper weighting (0 – 999d). If weighting is set as 0 the filter is disabled. The value specifies the weighting factor for the slope values obtained earlier, divided by 1000. Therefore, mathematically the weighting factor ranges from 0 to 1.

#### How is the position value filtered in TILTIX?

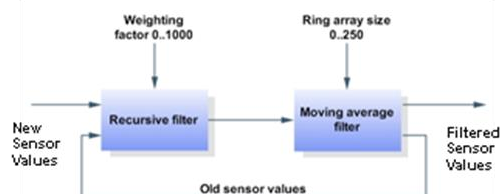

The above flow diagram explains the filter processing in TILTIX. Basically, the moving average filter is very effective in slow moving applications and the digital recursive filters are very effective in agile applications. A proper balance of both the

### USER MANUAL

#### TILTIX MEMS INCLINOMETER WITH CANOPEN INTERFACE

filters enables a smooth position output without any oscillations due to vibrations and similar disturbances. If the weighting factor is set very high and the moving average is also set to the maximum the position output experiences a very slow step response.

#### What are the considerations while setting the resolution of TILTIX?

The resolution can be set with the object 6000h. If attribute "resolution" is changed, side effects will occur while the sensor is adapting the set parameters to the configured resolution. This is because many other objects/parameters are set based on the resolution. Rounding effects have to be taken into account. Attributes affected:

*Write/Read:* Preset Slope Long16, Preset Slope Lateral16, Differential Slope Long16 Offset, Differential Slope Lateral16 Offset, Preset Slope Long32, Preset Slope Lateral32, Differential Slope Long32 Offset, Differential Slope Lateral32 Offset;

*Read Only:* Slope Long16, Slope Lateral16, Slope Long16 Offset, Slope Lateral16 Offset, Slope Long32, Slope Lateral32, Slope Lateral32 Offset, Slope Lateral32 Offset.

#### What is scaling and inversion? Explain with example?

Scaling and inversion are functionalities which are included in TILTIX to make the user handle and process the position output according to his need. This is generally controlled by the operation parameter objects (6011h / 6021h).

For example: Assume that the slope offset value is A8 and differential offset value is 0.

Scaling	Inversion	Position Value (in hex)
0	0	1043
0	1	EFBD
1	0	10EB
1	1	F065

- If 00, then position value is the actual position 1043 hex.
- If 01, then the position value is just inverted (-1043). This is (10000h – 1043) = EFBD hex.
- If 10, then the position is just scaled. (1043 + A8) is 10EB hex.
- If 11, then the position is inverted and scaled. Therefore, the new position value is (EFBD + A8) F065 hex.

### USER MANUAL

#### TILTIX MEMS INCLINOMETER WITH CANOPEN INTERFACE



If saving or restoring not all but only part of the parameters (communication, application or manufacturer parameters), Cyclic Time (object 2200) and Preset X, Preset Y (80° version, objects 2600 and 2601) or Preset (360° version, object 2600) show a special behavior: Cyclic Time is hardwired with the Event Timers of TxPDO1 and TxPDO2. If only the Event Timers (communication parameters) or Cyclic Time (Manufacturer parameter) is/are saved, the parameters would hold different values after a power off/on cycle. Therefore if the values do not match, the value of the event timers is copied to the Cycle Time, too. Preset parameters work the same way, with the application parameters (objects 6xxx) having the higher priority.



Slope long16, slope lateral16, slope long32 and slope lateral32 show the sensor output in the current resolution without any decimal point.



Terminal resistor is only activated, if the device is powered! This could lead under specific network conditions to problems.

### USER MANUAL

#### TILTIX MEMS INCLINOMETER WITH CANOPEN INTERFACE

## 11 Appendix A: TILTIX CANopen Objects

(ro- Read Only, wo- Write Only & rw – Read or Write )

### 11.1 Object 1000h: Device Type

The object at index 1000h describes the type of device and its functionality. It is composed of a 16-bit field which describes the device profile that is used and a second 16-bit field which gives additional information about optional functionality of the device. The additional information parameter is device profile specific.

Subindex	Description	Data Type	Default Value	Access
0	–	Unsigned 32	0X3019A <sup>1</sup> 0X4019A <sup>2</sup>	ro

1) Dual Axis

2) Single Axis

### 11.2 Object 1001h: Error Register

This object is used by the device to display internal faults. If a fault is detected, the corresponding bit is activated. The following errors are supported.

Bit	Description	Comments
0	Generic Error	The generic error is signaled at any error situation

The object description for error register.

Subindex	Description	Data Type	Default Value	Access
0	–	Unsigned 8	N/A	ro

### 11.3 Object 1003h: Pre-Defined Error Field

The object holds the errors that have occurred on the device and have been signaled via the Emergency Object. The error code is located in the least significant word and additional information is located in the most significant word. Sub-index 0 contains the number of recorded errors.

Subindex	Description	Data Type	Default Value	Access
0	Number of recorded errors	Unsigned 8	0	rw
1	Most recent errors	Unsigned 32	–	ro

**To clear error Log:** Write data 0 into sub-index 0 of object 1003.

### USER MANUAL

#### TILTIX MEMS INCLINOMETER WITH CANOPEN INTERFACE

#### 11.4 Object 1005h: COB-ID Sync

This object indicates the configured COB-ID of the synchronization object. In operational mode, sensor sends process data if SYNC message with same COB-ID is received. (Correct setting of transmission type of TxPDO(s) implied)

Subindex	Description	Data Type	Default Value	Access
0	–	Unsigned 32	0x80	rw

#### 11.5 Object 1008h: Mfr Device Name

This object contains the device name.

Subindex	Description	Data Type	Default Value	Access
0	–	String	–	ro

#### 11.6 Object 1009h: Mfr Hardware Version

This object contains the hardware version of the circuit board.

Subindex	Description	Data Type	Default Value	Access
0	–	String	–	ro

#### 11.7 Object 100Ah: Mfr Software Version

This object contains the manufacturer software version. The CA01 line has a major revision of 2. (02.xx)

Subindex	Description	Data Type	Default Value	Access
0	–	String	–	ro

#### 11.8 Object 100Ch: Guard Time

This object contains the guard time in milliseconds

Subindex	Description	Data Type	Default Value	Access
0	–	Unsigned 16	0	rw

### USER MANUAL

#### TILTIX MEMS INCLINOMETER WITH CANOPEN INTERFACE

#### 11.9 Object 100Dh: Life Time Factor

This object contains the life time factor parameters. The life time factor multiplied with the guard time gives the life time for the node guarding protocol.

Subindex	Description	Data Type	Default Value	Access
0	–	Unsigned 8	0	rw

#### 11.10 Object 1010h: Store Parameters

This object controls the saving of all writable parameters in non-volatile memory.

Subindex	Description	Data Type	Default Value	Access
0	Number of sub indices	Unsigned 8	4	ro
1	Save all parameters	Unsigned 32	–	rw
2	Save communication parameters	Unsigned 32	–	rw
3	Save application parameters	Unsigned 32	–	rw
4	Save manufacturer parameters	Unsigned 32	–	rw

**Storing Procedure:** To save the parameters to non-volatile memory, the access signature “save” has to be sent to the corresponding sub-index of the device.

	Most Significant Word		Least significant word	
ASCII	e	v	ASCII	e
Hex value	65h	76h	Hex value	65h



### USER MANUAL

#### TILTIX MEMS INCLINOMETER WITH CANOPEN INTERFACE

#### 11.11 Object 1011h: Restore Parameters

This object is used to restore device and CANOpen related writeable parameters to default factory settings.

Subindex	Description	Data Type	Default Value	Access
0	Number of sub indices	Unsigned 8	4	ro
1	Restore all parameters	Unsigned 32	–	rw
2	Restore communication parameters	Unsigned 32	–	rw
3	Restore application parameters	Unsigned 32	–	rw
4	Restore manufacturer parameters	Unsigned 32	–	rw

**Loading procedure:** To load the parameters from non volatile memory the access signature “load” has to be sent to the corresponding subindex of the device.

	Most Significant Word		Least significant word	
ASCII	d	a	ASCII	d
Hex value	64h	61h	Hex value	64h

Subindex	Description	Data Type	Default Value	Access
0	–	Unsigned 16	0x80+Node-ID	rw

**Note:** A power off/on sequence is required for the restoration to take place after the message has been transmitted.

#### 11.12 Object 1014h: COB-ID Emergency

This object indicates the configured COB-ID for the emergency write service. This has the highest priority among transmitted messages.

Subindex	Description	Data Type	Default Value	Access
0	–	Unsigned 32	0x81	rw

### USER MANUAL

#### TILTIX MEMS INCLINOMETER WITH CANOPEN INTERFACE

#### 11.13 Object 1016h: Consumer Heartbeat Time

The consumer heartbeat time defines the expected heartbeat cycle time in ms. The device can only monitor one corresponding device. If the time is set to 0 the monitoring is not active. The value of this object must be higher than the corresponding time (object 1017) of the monitored device.

Subindex	Description	Data Type	Default Value	Access
0	Number of indices	Unsigned 8	1	ro
1	Consumer heartbeat time	Unsigned 32	0	rw

The context of subindex 1 is as follows:

Bit	31 to 24	23 to 16	15 to 0
Value	0h (reserved)	Address of monitored device (Node-ID)	Monitoring time (ms)

#### 11.14 Object 1017h: Producer Heartbeat Time

The object contains the time interval in milliseconds in which the device has to produce a heartbeat message. The values are given in multiples of 1ms.

Subindex	Description	Data Type	Default Value	Access
0	–	Unsigned 16	0	rw

#### 11.15 Object 1018: Identity Object

This object provides the general identification of the inclinometer.

Subindex	Description	Data Type	Default Value	Access
0	Number of entries	Unsigned 8	0x4	ro
1	Vendor Id	Unsigned 32	0x42	ro
2	Product Code	Unsigned 32	0x43415032	ro
3	Revision Number	Unsigned 32	0x00010500 <sup>1</sup>	ro
4	Serial Number	Unsigned 32	–	ro

1) Prone to change with every revision.

### USER MANUAL

#### TILTIX MEMS INCLINOMETER WITH CANOPEN INTERFACE

##### 11.16 Object 2200h: Cyclic Timer

This object is used to determine the transmission interval during cyclic transmission mode. This object is hardwired with the event timers of TxPDO1 and TxPDO2. If cyclic timer and event timers of TxPDOs hold different values after power off/on cycle, the value of the event timers is copied to the cycle time.

Subindex	Description	Data Type	Default Value	Access
0	–	Unsigned 16	0	rw

##### 11.17 Object 2300h: Save Parameter with Reset

With this object all parameters can be stored in the non volatile memory. All parameters are saved with an additional reset executed afterwards.

Subindex	Description	Data Type	Default Value	Access
0	Access code	Unsigned 32	55AAAA55h	wo

##### 11.18 Object 2600h: Preset X-Axis (80° Version) / Preset (360° Version)

In TILTIX080 inclinometers, this object sets the X-axis to the desired value. It is hard-wired with objects 6012 and 6112. In TILTIX360 inclinometers, this object sets the Z-axis to the

Subindex	Description	Data Type	Default Value	Access
0	–	Integer 16	–	rw

The valid preset value ranges depend on the current resolution of the TILTIX. An error message will appear if the Preset value is out of range.

Resolution	Preset Range (in decimal)	
Type	TILTIX080	Type
1°	± 80	1°
0.1°	± 800	0.1°
0.01°	± 8000	0.01°

### USER MANUAL

#### TILTIX MEMS INCLINOMETER WITH CANOPEN INTERFACE

#### 11.19 Object 2601h: Preset Y-Axis (80° Version)

In TILTIX080 inclinometers, this object sets the Y-axis to a desired value. It is hard-wired with objects 6022 and 6122.

Subindex	Description	Data Type	Default Value	Access
0	–	Integer 16	–	rw

The valid preset value ranges depend on the current resolution of the TILTIX. An error message will appear if the preset value is out of range.

Resolution	Preset Range (in decimal)	
Type	TILTIX080	Type
1°	± 80	1°
0.1°	± 800	0.1°
0.01°	± 8000	0.01°

**After setting the Preset value a save command has to be given in order to set the Preset value permanently.**

#### 11.20 Object 3000h: Node Number

This object contains the node number of the device.

The POSITAL standard node number is 01 decimal.

The valid node numbers range from 01 to 127.

Subindex	Description	Data Type	Default Value	Access
0	Node Number	Unsigned 8	0	Rw

**NOTE:** To avoid the node number zero (0), one (1) will be added to the value of this object. E.g.: To set node number 32 decimal – Write 1F hex to the object and save. 1Fh+1h = 20h = 32 (dec) will finally

be set as the node number. **The new node number is only adopted after the device is reset, i.e. the node number needs to be saved prior to the reset to have an effect.**

### USER MANUAL

#### TILTIX MEMS INCLINOMETER WITH CANOPEN INTERFACE

#### 11.21 Object 3001h: Baud rate

This object contains the baud rate of the device. Valid value ranges from 0 to 7.

Subindex	Description	Data Type	Default Value	Access
0	Baud rate	Unsigned 8	–	rw*

Eight different baud rates are provided. To adjust the baud rate only one byte is used. The default baud rate is 125 kB (03h).

Baud rate in kB	Stored Value in Object
20	00h
50	01h
100	02h
125	03h
250	04h
500	05h
800	06h
1000	07h

**The new baud rate is only adopted after the device is reset, i.e. the baud rate needs to be saved prior to the reset to have an effect.**

#### 11.22 Object 3002h: Termination Resistor

This object is used to activate the termination resistor in case the TILTIX is used at the edges of the transmission line (to avoid reflection of data back into the line) and/or high transmission rates (>50kB).

Subindex	Description	Data Type	Default Value	Access
0	Activate Termination Resistor	Unsigned8	0	rw

For Activation<sup>1</sup> – Write 1 decimal to the sub index 0 of the object

For De-activation – Write 0 decimal to the sub index 0 of the object

**1)Note:** If activated, the termination resistor is only enabled while the device is powered.

### USER MANUAL

#### TILTIX MEMS INCLINOMETER WITH CANOPEN INTERFACE

#### 11.23 Object 3022h: Digital Recursive Filter

This particular object controls the weighting factor of the recursive filter. If set to 0, the filter is deactivated. Valid values range from 0 to 999. The value specifies the weighting factor for the slope values obtained earlier, divided by 1000. Therefore, mathematically the weighting factor ranges from 0 to 1.

Subindex	Description	Data Type	Default Value	Access
0	Digital Recursive Filter	Unsigned16	0	rw

For calculation of the position values with the recursive filter activated:

$$\text{New\_Sensor\_Value} = \{[\text{Weighting\_Factor} \times \text{Old\_Sensor\_Value}] + [(1 - \text{Weighting\_Factor}) \times \text{New\_Sensor\_Value}]\}$$

#### 11.24 Object 3100h: Moving Average Filter

This object contains the number of values which are averaged. If set to 0 then the filter is deactivated. The valid range of filter values accepted is from 0 to 250d.

Subindex	Description	Data Type	Default Value	Access
0	Moving Average Filter	Unsigned 16	100	rw

Internal Calculation of position values when MAF is activated with value N:

$$\text{New\_Sensor\_Value}_x = [\text{Sensor\_Value}_x + \text{Sensor\_Value}_{x-1} + \dots + \text{Sensor\_Value}_{x-N}] / N$$

#### 11.25 Object 6000h: Resolution

It is used to set the resolution i.e the minimum angle difference displayed by the TILTIX sensor. The default value is 10d (0A h).

Subindex	Description	Data Type	Default Value	Access
0	Resolution	Unsigned 16	–	rw

Three possible resolutions can be used:

Angular Resolution	Value decimal	Byte hex
0.01°	10	0A

### USER MANUAL

#### TILTIX MEMS INCLINOMETER WITH CANOPEN INTERFACE

#### 11.26 Object 6010h: Slope Long16

##### Position Value X-Axis (TILTIX080 – Longitudinal Axis) / Z-Axis (TILTIX360)

In TILTIX080 inclinometers, this object provides the X-axis position value and in TILTIX360 inclinometers, this object provides the Z-axis value. This a read only object and the position values are limited depending on the resolution set.

Subindex	Description	Data Type	Default Value	Access
0	–	Integer 16	–	ro

Angular Resolution	Range of Position Values	
	TILTIX080	TILTIX360
1°	± 80	1°
0.1°	± 800	0.1°
0.01°	± 8000	0.01°

##### Calculation of position / slope value from CANopen readout:

$$\text{Inclination (Degree)} = \text{Slope Long 16}[\text{Object 6010}] \times \text{Resolution} [\text{Object 6000}]$$



If attribute “resolution” is changed, side effects will occur, as the sensor is adapting the already set parameters to the configured resolution. Rounding effects have to be taken into account. Attributes affected: write/read: preset slope long16, preset slope lateral16, differential slope long16 offset, differential slope lateral16 offset, preset slope long32, preset slope lateral32, differential slope long32 offset, differential slope lateral32 offset; read only: slope long16, slope lateral16, slope long16 offset, slope lateral16 offset, slope long32, slope lateral32, slope lateral32 offset, slope lateral32 offset.

#### 11.27 Object 6011h: Slope Long16 Operating Parameter

This object controls the scaling and inversion of the slope long16 values. If bit 0 is set, inversion of slope long16 is enabled. If bit 1 is set, slope long16 offset and differential slope long16 offset are added to the slope long16. Both bits can be set at the same time.

Subindex	Description	Data Type	Default Value	Access
0	Position Scaling and Inversion	Unsigned 8	00	rw

##### Calculation of position value based on the operating parameter:

Slope Long16 = [(Physical inclination of slope long16 \* Multiplier) + Slope long16 Offset + Differential Slope long16 Offset]. With:

- Physical inclination of slope long16 (X)
- Multiplier: if inversion is disabled: 1, if inversion is enabled: -1

### USER MANUAL

#### TILTIX MEMS INCLINOMETER WITH CANOPEN INTERFACE

- Slope Long16 Offset (6013) = Slope Long16 Preset (6012) – (Physical inclination of slope long16 (X) at tacc \* Multiplier), with tacc = preset acquisition time
- Differential slope long16 offset (6014): Adds an absolute value (positive or negative) to the sensor

Bit 1	Bit 0	Position Calculation
0	0	X
0	1	-X (10000h – X for 16bit objects, 100000000h – X for 32bit objects)
1	0	(X + Object 6013h + Object 6014h)
1	1	(-X + Object 6013h + Object 6014h)

For detailed explanation please see the corresponding objects.

#### 11.28 Object 6012h: Slope Long16 Preset Value

This object is used to define a new, desired longitudinal slope value. The values will be set only according to the current resolution, so extreme care should be taken in order to be within the range of the position value limits.

Subindex	Description	Data Type	Default Value	Access
0	Preset Value	Integer 16	00	rw

Resolution	Preset Range (in decimal)	Type
1°	± 80	1°
0.1°	± 800	0.1°

#### 11.29 Object 6013h: Slope Long16 Offset

This is a read only parameter. The parameter is recalculated every time Slope Long16 preset (6012h), Slope Long32 Preset (6112) or Preset X (2600) objects are changed. This object does not exist for TILTIX360.

Subindex	Description	Data Type	Default Value	Access
0	Offset Value	Integer 16	–	ro

#### Calculation of Slope Long16 Offset:

Offset Value = Preset Value – (Physical Value \* Inversion)

[Inversion is -1 if activated; 1 if deactivated]



### USER MANUAL

#### TILTIX MEMS INCLINOMETER WITH CANOPEN INTERFACE

#### 11.30 Object 6014h: Differential Slope Long16 Offset

This parameter adds an additional, independent offset to slope long16, but only if scaling of slope long16 is enabled. Please note that the values should be within the range of position attribute according to the resolution already set.

Subindex	Description	Data Type	Default Value	Access
0	Offset Value	Integer 16	–	rw

The main difference between the objects 6013h and 6014h is that, 6013 is calculated automatically depending on the preset value whereas object 6014h is user defined.

#### 11.31 Object 6020h: Slope Lateral16

##### Position Value Y-Axis (ACS080 – Lateral Axis)

In ACS080 inclinometers, this object provides the Y-axis position value. This a read only object and the position values are limited depending on the resolution set.

Subindex	Description	Data Type	Default Value	Access
0	–	Integer 16	–	ro

Resolution	Preset Range (in decimal)
Type	ACS080
1°	± 80
0.1°	± 800
0.01°	± 8000

#### Calculation of position / slope value from CANopen readout:

Inclination (Degree) = Slope Lateral 16[Object 6020] x Resolution [Object 6000]

### USER MANUAL

#### TILTIX MEMS INCLINOMETER WITH CANOPEN INTERFACE

#### 11.32 Object 6021h: Slope Lateral16 Operating Parameter

This object controls the scaling and inversion of the slope lateral16 values. If bit 0 is set, inversion of slope lateral16 is enabled. If bit 1 is set, slope lateral16 offset and differential slope lateral16 offset are added to the slope lateral16. Both bits can be set at the same time.

Subindex	Description	Data Type	Default Value	Access
0	Position Scaling and Inversion	Unsigned 8	00	rw

#### Calculation of position value based on the operating parameter:

Slope Lateral16 = [(Physical inclination of slope lateral16 \* Multiplier) + Slope lateral16 Offset + Differential Slope lateral16 Offset]

With:

- Physical inclination of slope lateral16 (X)
- Multiplier: if inversion is disabled: 1, if inversion is enabled: -1
- Slope Lateral16 Offset (6023) = Slope Lateral16 Preset (6022) – (Physical inclination of slope lateral16 (X) at  $t_{acc}$  \* Multiplier), with  $t_{acc}$  = preset acquisition time
- Differential slope lateral16 offset (6024): Adds an absolute value (positive or negative) to the sensor output.

Bit 1	Bit 0	Position Calculation
0	0	X
0	1	-X (10000h – X for 16bit objects, 100000000h – X for 32bit objects)
1	0	(X + Object 6023h + Object 6024h)
1	1	(-X + Object 6023h + Object 6024h)

For detailed explanation please see the corresponding objects.

### USER MANUAL

#### TILTIX MEMS INCLINOMETER WITH CANOPEN INTERFACE

#### 11.33 Object 6022h: Slope Lateral16 Preset Value

This object is used to define a new, desired lateral slope value. The values will be set only according to the current resolution, so extreme care should be taken in order to be within the range of the position value limits.

Subindex	Description	Data Type	Default Value	Access
0	Preset Value	Integer 16	00	rw

Resolution	Preset Range (in decimal)
Type	ACS080
1°	± 80
0.1°	± 800
0.01°	± 8000

#### 11.34 Object 6023h: Slope Lateral16 Offset

This is a read only parameter. The parameter is (6022h), Slope Lateral32 Preset (6122) or Preset Y recalculated every time Slope Lateral16 preset (2601) objects are changed.

Subindex	Description	Data Type	Default Value	Access
0	Offset Value	Integer 16	–	ro

#### Calculation of Slope Lateral16 Offset:

Offset Value = Preset Value – (Physical Value \* Inversion) [Inversion is -1 if activated; 1 if deactivated]

#### 11.35 Object 6024h: Differential Slope Lateral16 Offset

This parameter adds an additional, independent offset to slope lateral16, but only if scaling of slope lateral16 is enabled. Please note that the values should be within the range of position attribute according to the resolution already set.

Subindex	Description	Data Type	Default Value	Access
0	Offset Value	Integer 16	–	rw

The main difference between the objects 6023h and 6024h is that, 6023 is calculated automatically depending on the preset value whereas object 6024h is user defined.

#### 32-Bit Objects (61XX)

Object 6110 – 6114: Hardwired with 16-bit slope long16 objects.

Objects 6120 – 6124: Hardwired with 16-bit slope lateral16 objects.

### USER MANUAL

#### TILTIX MEMS INCLINOMETER WITH CANOPEN INTERFACE

##### 11.36 Object 6114h: Differential Slope Long32 Offset (ACS360)

This parameter adds an additional, independent offset to the slope long32, but only if scaling of slope long32 is enabled. The values will be set only according to the current resolution, so extreme care should be taken in order to be within the range of the position value limits.

Subindex	Description	Data Type	Default Value	Access
0	Offset Value	Integer 32	-	rw

Resolution	Differential Offset Range (in decimal)
Type	ACS0360
1°	-179 to +180
0.1°	-1799 to +1800
0.01°	-17999 to +18000

# POSITAL

## FRABA

### USER MANUAL

#### TILTIX MEMS INCLINOMETER WITH CANOPEN INTERFACE

#### Overview of Objects

Object Name	Object No. ID hex	Access	Data Type
Device type	1000	Read-only	UNSIGNED32
Error Register	1001	Read-only	UNSIGNED8
Predefined Error Field	1003	–	ARRAY
Sub 0: Number of errors	1003.0	Read/write	UNSIGNED8
Sub 1: New error	1003.1	Read-only	UNSIGNED32
COB-ID SYNC	1005	Read/write	UNSIGNED32
Device Name	1008	Read-only	VISIBLE_STRING
Hardware Version	1009	Read-only	VISIBLE_STRING
Software Version	100a	Read-only	VISIBLE_STRING
Guard Time	100c	Read/write	UNSIGNED16
Life Time Factor	100d	Read/write	UNSIGNED8
Store Parameters	1010	–	ARRAY
Highest sub-index supported	1010.0	Read-only	UNSIGNED8
Save all parameters	1010.1	Read/write	UNSIGNED32
Save communication parameters	1010.2	Read/write	UNSIGNED32
Save Application parameters	1010.3	Read/write	UNSIGNED32
Save Manufacturer parameters	1010.4	Read/write	UNSIGNED32
Restore Default Parameters	1011	–	ARRAY
Highest sub-index supported	1011.0	Read-only	UNSIGNED8
Restore all parameters	1011.1	Read/write	UNSIGNED32
Restore communication parameters	1011.2	Read/write	UNSIGNED32
Restore application parameters	1011.3	Read/write	UNSIGNED32
Restore manufacturer parameters	1011.4	Read/write	UNSIGNED32
COB-ID Emergency	1014	Read-only	UNSIGNED32
Consumer Heartbeat Time	1016	–	ARRAY
Sub 0: No. of Entries	1016.0	Read-only	UNSIGNED8
Sub 1: Consumer Heartbeat Time	1016.1	Read/write	UNSIGNED32
Producer Heartbeat Time	1017	Read/write	UNSIGNED16
Identity Object	1018	–	RECORD
Number of Entries	1018.0	Read-only	UNSIGNED8
Vendor ID	1018.1	Read-only	UNSIGNED32
Product Code	1018.2	Read-only	UNSIGNED32
Revision Number	1018.3	Read-only	UNSIGNED32
Serial Number	1018.4	Read-only	UNSIGNED32
TxPDO1 Comm Parameter	1800	–	RECORD
Sub 0: No. of Entries	1800.0	Read-only	UNSIGNED8

# POSITAL

## FRABA

### USER MANUAL

#### TILTIX MEMS INCLINOMETER WITH CANOPEN INTERFACE

Sub 1: COB-ID	1800.1	Read/write	UNSIGNED32
Sub 2: Transmission Type	1800.2	Read/write	UNSIGNED8
Sub 3: Inhibit Time	1800.3	Read/write	UNSIGNED16
Sub 5: Event Timer	1800.5	Read/write	UNSIGNED16
TxPDO2 Comm Parameter	1801	–	RECORD
Sub 0: No. of Entries	1801.0	Read-only	UNSIGNED8
Sub 1: COB-ID	1801.1	Read/write	UNSIGNED32
Sub 2: Transmission Type	1801.2	Read/write	UNSIGNED8
Sub 3: Inhibit Time	1801.3	Read/write	UNSIGNED16
Sub 5: Event Timer	1801.5	Read/write	UNSIGNED16
TxPDO1 Mapping	1a00	–	RECORD
Sub 0: Number of entries	1a00.0	Read-only	UNSIGNED8
Sub 1: 1 <sup>st</sup> mapped object	1a00.1	Read/write	UNSIGNED32
Sub 2: 2 <sup>nd</sup> mapped object	1a00.2	Read/write	UNSIGNED32
TxPDO2 Mapping	1a01	–	RECORD
Sub 0: Number of entries	1a01.0	Read-only	UNSIGNED8
Sub 1: 1 <sup>st</sup> mapped object	1a01.1	Read/write	UNSIGNED32
Sub 2: 2 <sup>nd</sup> mapped object	1a01.2	Read/write	UNSIGNED32
Cyclic Time	2200	Read/write	UNSIGNED16
Store Parameters	2300	Write-only	UNSIGNED32
Preset X-Axis (80° version), Preset (360°version)	2600	Read/write	INTEGER16
Preset Y-Axis (only 80° version)	2601	Read/write	INTEGER16
Node Number	3000	Read/write	UNSIGNED8
Baud rate	3001	Read/write	UNSIGNED8
Termination Resistor	3002	Read/write	UNSIGNED8
Digital Recursive Filter	3022	Read/write	UNSIGNED16
Moving Average Filter	3100	Read/write	UNSIGNED16
Resolution	6000	Read/write	UNSIGNED16
Slope long16	6010	Read-only	INTEGER16
Slope long16 operating parameter	6011	Read/write	UNSIGNED8
Slope long16 preset value	6012	Read/write	INTERGER16
Slope long16 offset	6013	Read-only	INTEGER16
Differential slope long16 offset	6014	Read/write	INTEGER16
Slope lateral16 (only 80° version)	6020	Read-only	INTEGER16
Slope lateral16 operating parameter (only 80° version)	6021	Read/write	UNSIGNED8
Slope lateral16 preset value (only 80° version)	6022	Read/write	INTEGER16

### USER MANUAL

#### TILTIX MEMS INCLINOMETER WITH CANOPEN INTERFACE

Slope lateral16 offset (only 80° version)	6023	Read-only	INTEGER16
Differential slope lateral16 offset (only 80° version)	6024	Read/write	INTEGER16
All 32-bit objects	61XX	-	-

If saving or restoring not all but only part of the parameters (communication, application or manufacturer parameters), Cyclic Time (object 2200) and Preset X, Preset Y (80° version, objects 2600 and 2601) or Preset (360° version, object 2600) show a special behavior:



Cyclic Time is hardwired with the Event Timers of TxPDO1 and TxPDO2. If only the Event Timers (communication parameters) or Cyclic Time (Manufacturer parameter) is/are saved, the parameters would hold different values after a power off/on cycle. Therefore if the values do not match, the value of the event timers is copied to the Cycle Time, too. Preset parameters work the same way, with the application parameters (objects 6xxx) having the higher priority.

### USER MANUAL

#### TILTIX MEMS INCLINOMETER WITH CANOPEN INTERFACE

## 12 Appendix C: Output Graphs

### 12.1 TILTIX 360: CANopen Output Values

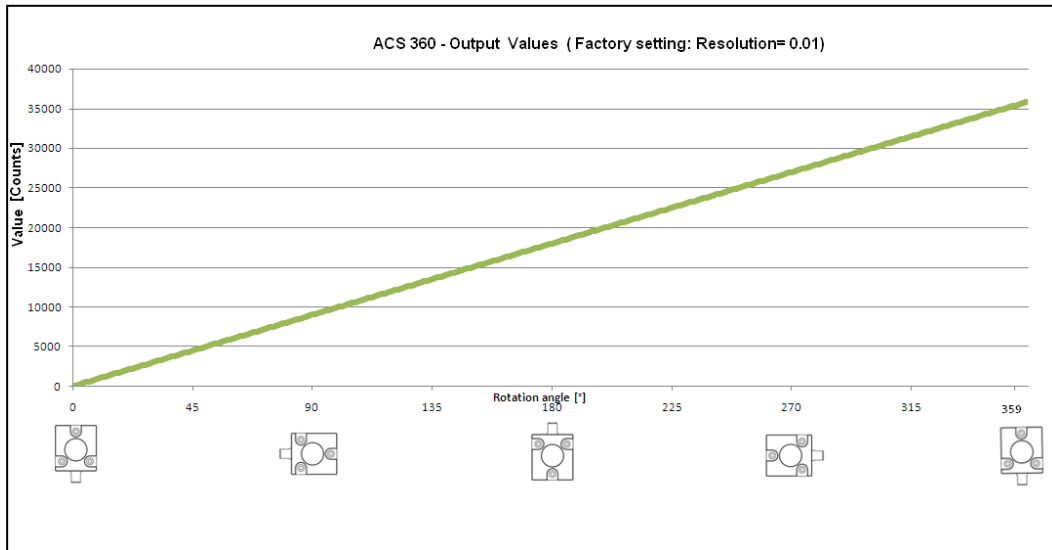

### 12.2 TITIX 080 : CANopen Output Values

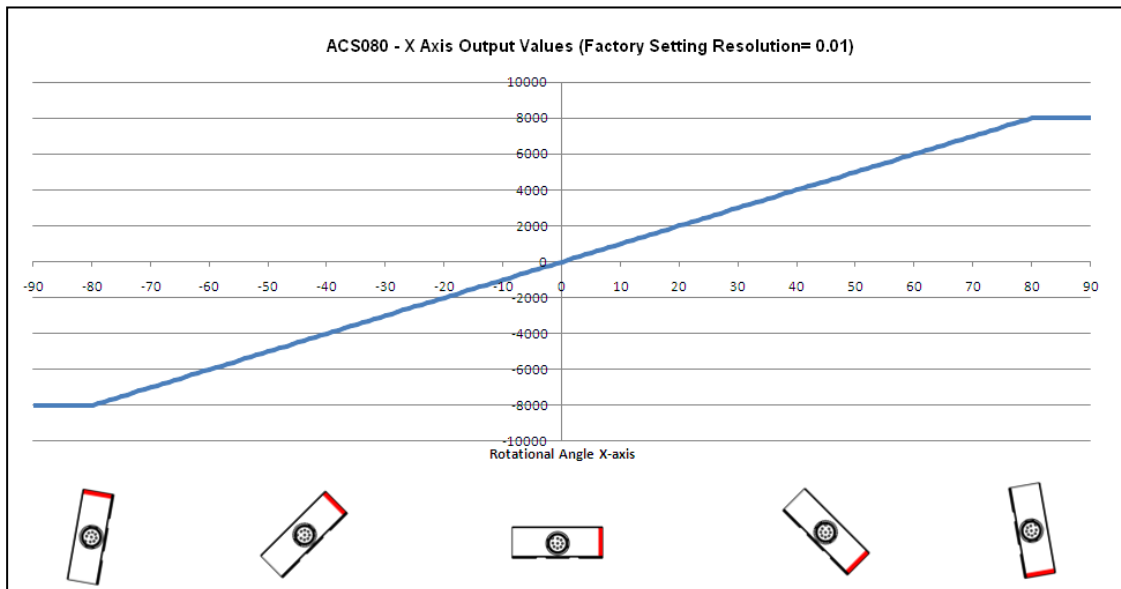



## USER MANUAL TILTIX MEMS INCLINOMETER WITH CANOPEN INTERFACE

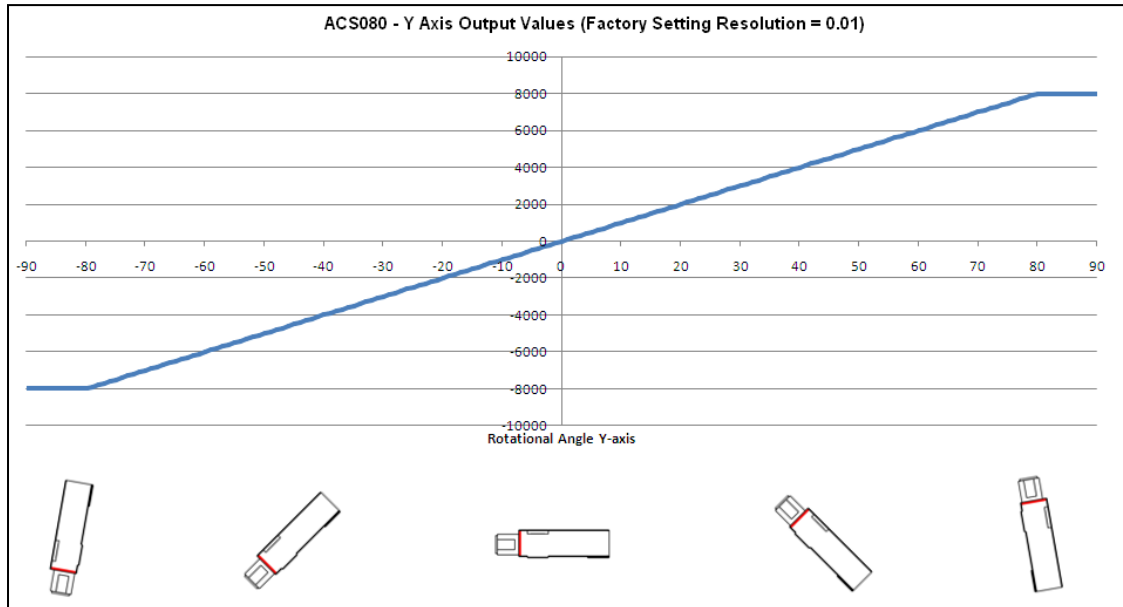

USER MANUAL  
TILTIX MEMS INCLINOMETER WITH CANOPEN INTERFACE

**13 Glossary**

(For more detailed information refer to CiA's CAN Dictionary)

**A**

Address	Number, assigned to each node, irrespective of whether it is a master or slave. The inclinometer address (non-volatile) is configured in the base with rotary switches.
APV	Absolute Position Value.

**B**

Bandwidth transmitted	Bandwidth is the value, which denominates the size of information in a defined time unit.
Baud rate	Transmission speed formulated in number of bits per second. Bus node Device that can send and/or receive or amplify data by means of the bus.
Bit Rate	Number of bits per time during transmission, independent of bit representation. The bit rate in CAN networks is limited to 1 Mbit/s.
Bus	Topology of a communication network, where all nodes are reached by passive links. This allows transmission in both directions.
Byte	8-bit unit of data = 1 byte.

**C**

CAL	CAN application layer. Application layer developed by CiA (CAN in Automation) members providing several communication services and corresponding protocols.
CAN	Controller Area Network or CAN multiplexing network.
CANopen	Application layer of an industrial network based on the CAN bus.
CCW	Counter-clockwise
CiA	CAN In Automation, organization of manufacturers and users of devices that operate on the CAN bus.
CiA 410	The CANopen device profile for inclinometer supports 16-bit as well as 32-bit sensors
COB	Elementary communication object on the CAN network. All data is transferred using a COB.
COB-ID	COB-Identifier. Identifies an object in a network. The ID determines the transmission priority of this object. The COB-ID consists of a function code and a node number.
CW	Clockwise

**E**

Event Timer	The event timer is assigned in CANopen to one PDO. It defines the frequency of PDO transmission.
-------------	--

### USER MANUAL

### TILTIX MEMS INCLINOMETER WITH CANOPEN INTERFACE

#### F

FC Determines the type of message sent via the CAN network.  
Function Code

#### H

Heartbeat CANOpen and DeviceNet use the heartbeat message to indicate that a node is still alive. This message is transmitted periodically.

Heartbeat Consumer The heartbeat consumer time defines time interval required by the monitoring node Time to verify, whether a monitored node is alive or not. In case, the monitored node transmits no heartbeat message within that time interval, it is regarded as not alive.

#### L

Line terminator Resistor terminating the main segments of the bus.

LMT Network management object. This is used to configure the parameters of each layer in the CAN. Master "Active" device within the network, that can send data without having received a request. It controls data exchange and communication management.

#### N

NMT Network management object. This is responsible for managing the execution, configuration and errors in a CAN network.

NN Node number

#### P

PCV Process Value

PDO Communication object, with a high priority for sending process data.

PV Preset Value: Configuration value

#### R

RO Read Only: Parameter that is only accessible in read mode.

ROMAP Read Only MAPable: Parameter that can be polled by the PDO.

RW Read/Write: Parameter that can be accessed in read or write mode.

#### S

SDO Communication object, with a low priority for messaging (configuration, error handling, diagnostics). Slave Bus node that sends data at the request of the master. The inclinometers are always slaves.

#### W

WO Write Only: Parameter that is only accessible in write mode.

USER MANUAL  
TILTIX MEMS INCLINOMETER WITH CANOPEN INTERFACE

**14 Disclaimer**

© FRABA B.V. all rights reserved. We do not assume responsibility for technical inaccuracies or omissions. Specifications are subject to change without notice.