

N.b. ROD-EYE ORIENTATION NOT GUARANTEED.

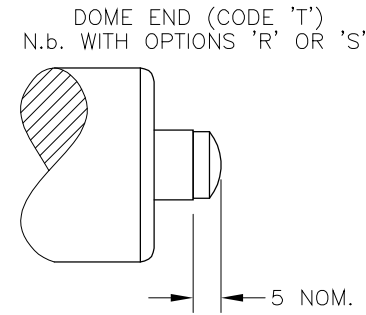
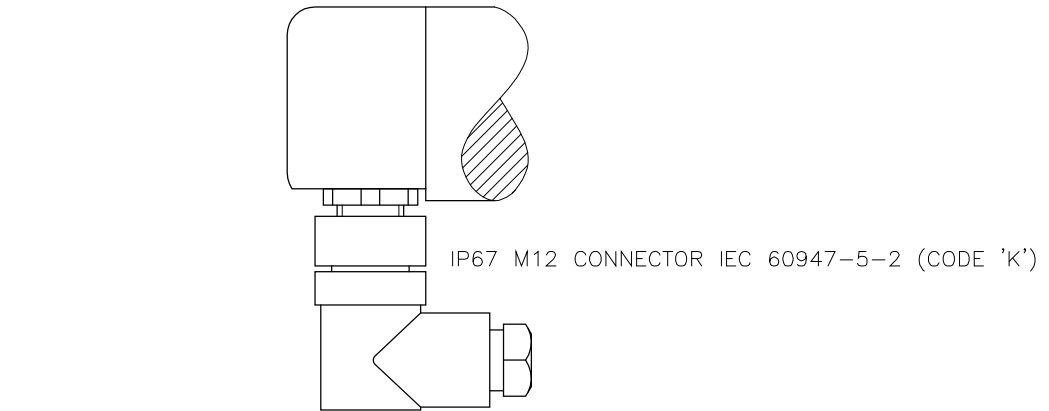
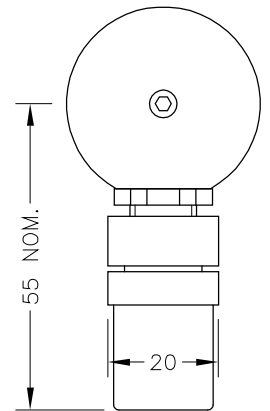
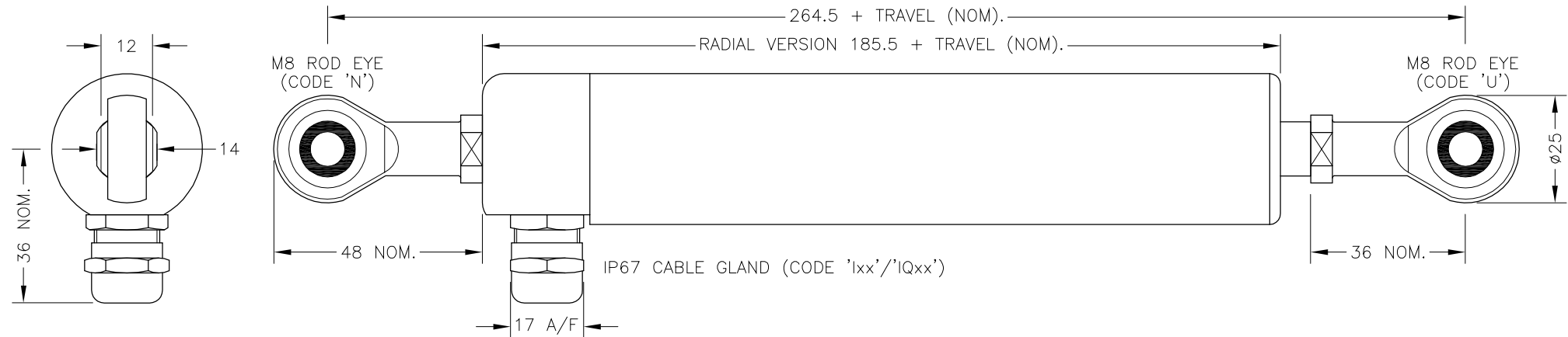
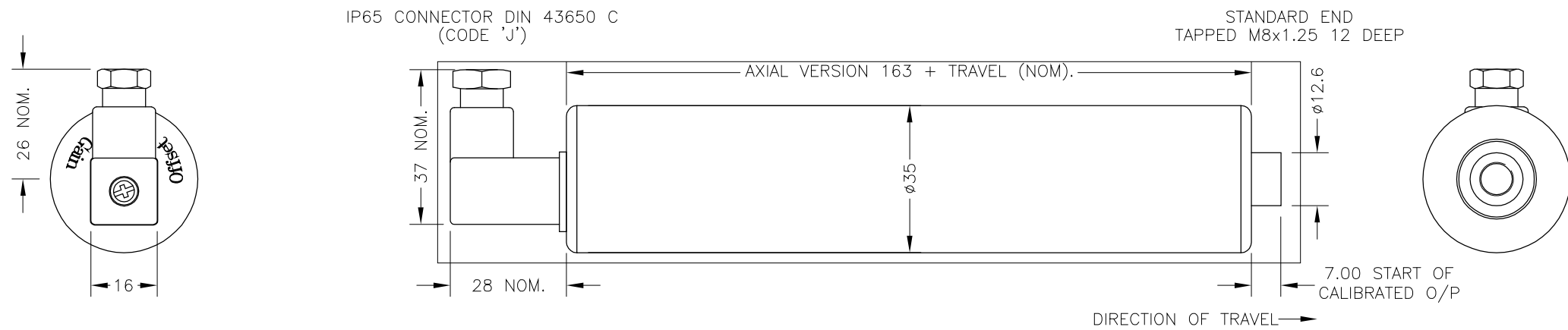

ELECTRICAL OPTIONS/ SPECIFICATIONS

OUTPUT	SUPPLY		
0.5 TO 4.5V RATIOMETRIC	5V		
SUPPLY CURRENT 12mA TYP. 20mA MAX.			
CABLE: 0.2mm ² , O/A SCREEN, PUR JACKET - SUPPLIED WITH 50cm OR REQUIRED LENGTH IN cm (15000cm MAX).			
STANDARD 3-CORE: JACKET Ø4mm BLACK e.g. 'L50'			
OPTIONAL 5-CORE: JACKET Ø4.6mm BLUE e.g. 'LQ50'			
CABLE/CONNECTOR* CONNECTIONS;			
3 CORE	5 CORE	CONNECTOR	
RED	RED	:1	+Ve
-	ORG	:1	+SENSE (5-WIRE ONLY)
BLACK	BLACK	:3	0V
-	GRY	:3	-SENSE (5-WIRE ONLY)
WHITE	WHITE	:2	OUTPUT
SCREEN	SCREEN	:4	BODY

*CONNECTORS; MAXIMUM CONDUCTOR CROSS SECTION 0.75mm²
 RANGE OF DISPLACEMENT FROM 0-5mm TO 0-800mm e.g.76, IN INCREMENTS OF 1mm.

BODY MATERIAL: STAINLESS STEEL.
 FURTHER OPTIONS:
 SINGLE PAIR OF BODY CLAMPS 'P'
 TWO PAIRS OF BODY CLAMPS 'P2'
 SPRING RETURN PUSH-ROD, TRAVEL ≤300mm
 RETURN TO EXTENDED POSITION (CODE 'R')
 RETURN TO RETRACTED POSITION (CODE 'S')
 PUSH-ROD FREE (CODE 'V') - NOT AVAILABLE WITH SPRUNG OPTIONS.
 GAIN AND OFFSET ADJUSTMENTS NOT AVAILABLE WITH RADIAL BODY, CODE 'lxx' AND 'k', OPTIONS.

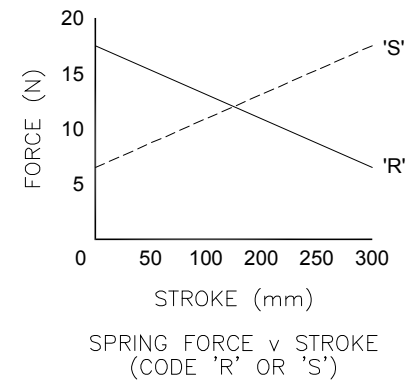

NOTE:- READ INSTALLATION SHEET G000-19 FOR FULL INSTRUCTIONS FOR USE.

CSA APPROVED TO
 Class I Zone 0
 Ex/AEx ia IIC T4 (Ta= -40 to 80°C)
 Ui 11.4V, Ii 0.2A, Pi 0.51W

APPROVED FOR USE IN CONJUNCTION WITH A GALVANICALLY ISOLATED BARRIER.

NOTE: APPROVAL ONLY APPLIES AT NORMAL ATMOSPHERIC PRESSURE!

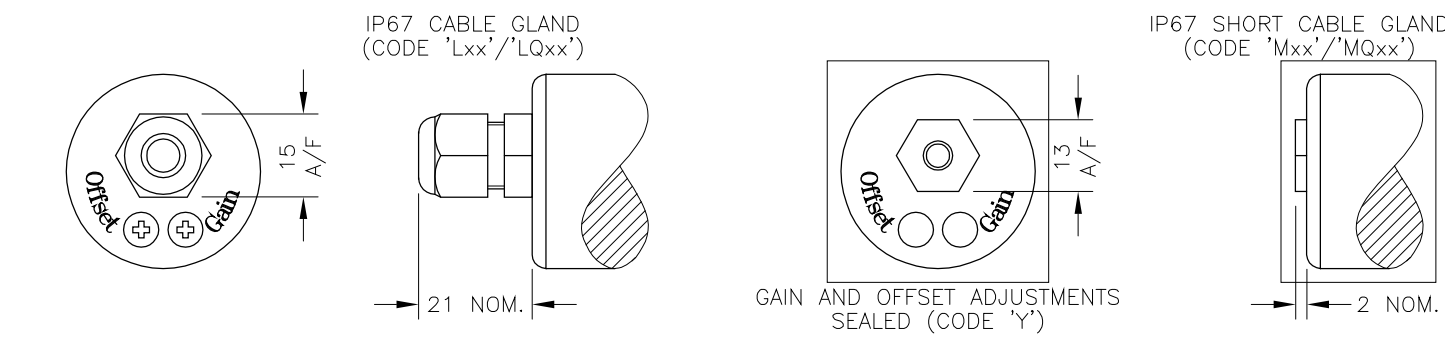

A	FIRST ISSUE.	PDM
B	SPRUNG OPTIONS 300 WAS 250 - RAN 473.	PDM
C	OPTIONS 'R' & 'S' OVER TRAVEL DIMS MODIFIED - RAN1030.	PDM
D	RANGE WAS 50-600mm RAN1056	RDS
E	5-CORE OPTION ADDED ~ RAN1102	PDM
F	RANGE NOTE AMENDED ~ RAN1200	PDM



THE PUSH-ROD RETRACTS A FURTHER 4mm NOM. FROM START OF CALIBRATED TRAVEL. STANDARD VERSIONS THE PUSH-ROD EXTENDS A FURTHER 8mm NOM. FROM END OF CALIBRATED TRAVEL, FOR SPRUNG VERSIONS: 'R': 1mm, 'S': 2mm. 'V' CODED PUSH-ROD WILL DEPART SENSOR BODY.

DRAWINGS NOT TO BE CHANGED WITHOUT REFERENCE TO THE CHANGE PROCEDURE. CHANGES TO PARTS USED IN INTRINSICALLY SAFE PRODUCT MUST BE APPROVED BY THE AUTHORISED PERSON. THIS IS AN UNCONTROLLED PRINT AND WILL NOT BE UPDATED.



A	08/03/13	CHECKED BY RDS	X ±0.4
B	08/04/14		X.X ±0.2
C	28/07/15		X.XX ±0.1 DIMS mm
D	9/11/15	DESCRIPTION	
E	07/04/17	G111 INTRINSICALLY SAFE	
F	29/08/17	RUGGED STAND ALONE LINEAR POSITION SENSOR	
SCALE 12.5mm		DRAWING NUMBER	G111-11 REV F
		SHEET 1 OF 1	

LIPS® G111 RUGGED STAND-ALONE LINEAR POSITION SENSOR

INTRINSICALLY SAFE FOR HAZARDOUS GAS/VAPOUR ATMOSPHERES

- Intrinsically safe for Gas to:
Class I, Zone 0 Ex ia / AEx ia
- Non-contacting inductive technology to eliminate wear
- Travel set to customer's requirement
- High durability and reliability
- High accuracy and stability
- Sealing to IP67



As a leading designer and manufacturer of linear, rotary, tilt and intrinsically safe position sensors, Positek® has the expertise to supply a sensor to suit a wide variety of applications.

Our G111 LIPS® (Linear Inductive Position Sensor) incorporates electronics system EX06 which is CSA approved for use in potentially explosive gas/vapour atmospheres. This heavy-duty version of the G101 sensor with a stronger 12.6mm push rod, recommended for applications where vibration is an issue or there is a need for longer travel sensors, mounted horizontally, and supported between rod eyes. It remains an affordable, durable, high-accuracy position sensor designed for industrial and scientific feedback applications. The unit is highly compact and space-efficient, being responsive along almost its entire length. Like all Positek® sensors, the G111 provides a linear output proportional to travel. Each sensor is supplied with the output calibrated to the travel required by the customer, any stroke from 0-5mm to 0-800mm and with full EMC protection built in.

The sensor is very robust, the body and push rod being made of stainless steel for long service life and environmental resistance. Overall performance, repeatability and stability are outstanding over a wide temperature range. The sensor is easy to install with mounting options including M8 rod eye bearings and body clamps. The push rod can be supplied free or captive, with female M8 thread, an M8 rod eye, or dome end. Captive push rods can be sprung loaded, in either direction, on sensors up to 300mm of travel. The G111 also offers a wide range of mechanical options, environmental sealing is to IP65 or IP67, depending on selected cable or connector options.

SPECIFICATION

Dimensions	
Body diameter	35 mm
Body length (Axial version)	calibrated travel + 163 mm
Body length (Radial version)	calibrated travel + 186 mm
Push rod extension	calibrated travel + 7 mm, OD 12.6 mm
For full mechanical details see drawing G111-11	
Power Supply	+5V dc nom. ± 0.5V, 10mA typ 20mA max
Output Signal	0.5-4.5V dc ratiometric, Load: 5kΩ min.
Independent Linearity	≤ ± 0.25% FSO @ 20°C - up to 450 mm ≤ ± 0.5% FSO @ 20°C - over 450 mm ≤ ± 0.1% FSO @ 20°C* available upon request.
*Sensors with calibrated travel from 10 mm up to 400 mm.	
Temperature Coefficients	< ± 0.01%/°C Gain & < ± 0.01%FS/°C Offset
Frequency Response	> 10 kHz (-3dB)
Resolution	Infinite
Noise	< 0.02% FSO
Intrinsic Safety	Class I, Zone 0 Ex ia IIC T4 (Ta = -40°C to +80°C) AEx ia IIC T4 (Ta = -40°C to +80°C)
Approval only applies to the specified ambient temperature range and atmospheric conditions in the range 0.80 to 1.10 Bar, oxygen = 21%	
Sensor Input parameters	Ui: 11.4V, Ii: 0.20A, Pi: 0.51W.
(connector option/s)	Ci: 1.16µF, Li: 50µH
(cable option/s)	Ci: 1.36µF, Li: 710µH with 1km max. cable
Environmental Temperature Limits	
Operating	-40°C to +80°C
Storage	-40°C to +125°C
Sealing	IP65/IP67 depending on connector / cable option
EMC Performance	EN 61000-6-2, EN 61000-6-3
Vibration	IEC 68-2-6: 10 g
Shock	IEC 68-2-29: 40 g
MTBF	350,000 hrs 40°C Gf
Drawing List	
G111-11	Sensor Outline
Drawings, in AutoCAD® dwg or dxf format, available on request.	

Do you need a position sensor made to order to suit a particular installation requirement or specification? We'll be happy to modify any of our designs to suit your needs - please contact us with your requirements.

LIPS[®] G111 RUGGED STAND-ALONE LINEAR POSITION SENSOR

INTRINSICALLY SAFE FOR HAZARDOUS GAS/VAPOUR ATMOSPHERES

Intrinsically safe equipment is defined as "equipment which is incapable of releasing sufficient electrical or thermal energy under normal or abnormal conditions to cause ignition of a specific hazardous atmosphere mixture in its most easily ignited concentration."

CSA approved to;

Class I, Zone 0
 Ex ia IIC T4 (Ta = -40°C to +80°C)
 AEx ia IIC T4 (Ta = -40°C to +80°C)

Designates the sensor as belonging to; Class I, Zone 0: can be used in areas with continuous, long or frequent periods of exposure to hazardous gas / vapours.

Protection class ia IIC, denotes intrinsically safe for Zones 0, 1 & 2 and IIA, IIB and IIC explosive gases.

Temperature class T4: maximum sensor surface temperature under fault conditions 135°C.

Ambient temperature range extended to -40°C to +80°C.

It is imperative Positek[®] intrinsically safe sensors be used in conjunction with a galvanic barrier to meet the requirements of the product certification. The Positek G005 Galvanic Isolation Amplifier is purpose made for Positek IS sensors making it the perfect choice. Refer to the G005 datasheet for product specification and output configuration options.

Safety Parameters:-

Ui: 11.4V, Ii: 0.20A, Pi: 0.51W
 Ci = 1.36µF* Li = 710µH* (cable option/s)
 Ci = 1.16µF Li = 50µH (connector option/s)

*Figures for 1km cable where: Ci = 200pF/m & Li = 660nH/m

Sensors can be installed with a maximum of 1000m of cable.

Cable characteristics must not exceed:-

Capacitance: ≤ 200 pF/m for max. total of: 200 nF.

Inductance: ≤ 660 nH/m for max. total of: 660 µH

For cable lengths exceeding 10 metres a five wire connection is recommended to eliminate errors introduced by cable resistance and associated temperature coefficients.

CSA approved sensors suitable for dust (H series, USA only) applications, are also available from Positek.

TABLE OF OPTIONS

CALIBRATED TRAVEL: Factory set to any length from 0-5mm to 0-800mm (e.g. 254mm)

ELECTRICAL INTERFACE OPTIONS

Axial sensors supplied with access to output 'zero' and 'span' calibration adjustments as standard. No access option available.

The Positek[®] G005 Galvanic Isolation Amplifier is available with the following output options:

Standard: 0.5 - 9.5V or 4 - 20mA.

Reverse: 9.5 - 0.5V or 20 - 4mA.

CONNECTOR/CABLE OPTIONS

Connector - Hirschmann GD series Axial, IP65

Connector - Hirschmann ELWIK 4102 Radial, IP67

Cable[†] with M12 gland or short gland Axial, IP67

Cable[†] with Pg 9 gland Radial, IP67

[†]Three core (black jacket) or five core (blue jacket) cable options available.

Cable length >50 cm – please specify length in cm up to 15000 cm max.

We recommend all customers refer to the 3 or 5-Wire Mode Connection page.

MOUNTING OPTIONS

M8 rod eye bearing (radial versions), Body Tube Clamp/s (axial or radial versions).

PUSH ROD OPTIONS – standard retained with M8x1.25 female thread, M8 rod eye bearing, Dome end, Sprung loaded (retraction or extension) or Free.

Output Characteristic - Standard

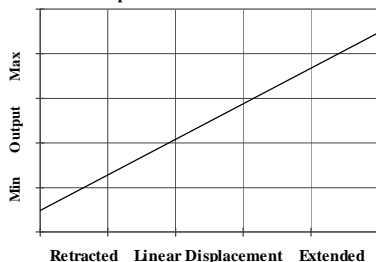

For further information please contact:

www.positek.com sales@positek.com

Tel: +44(0)1242 820027 fax: +44(0)1242 820615

Positek Ltd, Andoversford Industrial Estate, Cheltenham GL54 4LB U.K.



G111-17d

Three or Five-Wire Mode Connection FOR INTRINSICALLY SAFE SENSORS IN HAZARDOUS ATMOSPHERES

The aim of this document is to help readers who do not understand what is meant by three or five wire modes of connection between the galvanic isolation amplifier and sensor, and the factors behind them. It is by no means an in-depth technical analysis of the subject.

Whether opting for a pre-wired Positek® Intrinsicly Safe sensor or one with a connector, choosing the right mode of connection and cable to suit the application requires careful consideration.

Interconnecting cables are not perfect conductors and offer resistance to current flow, the magnitude of resistance[†] depends on conductors resistivity, which changes with temperature, cross sectional area[‡] and length. If the voltage were to be measured at both ends of a length of wire it would be found they are different, this is known as volts drop. Volts drop changes with current flow and can be calculated using Ohm's law, it should be noted that volts drop occurs in both positive and negative conductors. The effects of volts drop can be reduced by increasing the conductors cross sectional area, this does not however eliminate the effects due to temperature variation. There are instances where large cross-section cables are not practical; for example most standard industrial connectors of the type used for sensors have a maximum conductor capacity of 0.75mm², copper prices and ease of installation are other considerations.

This is important because the effects of volts drop can significantly alter the perceived accuracy of the sensor which is ratiometric i.e. the output signal is directly affected by the voltage across the sensor. Changes in temperature will also be seen as gain variation in the sensor output.

Three wire mode connections are common and are suitable in most cases with short or moderate cable runs. Applications that do not require a high degree of accuracy but have cable runs, say in excess of 10m, volts drop can be reduced by introducing a terminal box close to the sensor and using a larger cross-section cable for a majority of the cable run. Sensors supplied with three core cable are calibrated with the cable fitted which largely eliminates errors due to conductor resistance at room temperature however, as mentioned above, small gain errors due to temperature fluctuations should be expected.

Five wire mode connections have significant benefits as losses in the positive and negative conductors are compensated for by the galvanic isolation amplifier which can 'sense' the voltage across the sensor and dynamically adjust the output voltage so that the voltage across the sensor is correct. The effects of cable resistance and associated temperature coefficients are eliminated allowing for smaller conductors than a three wire connection for the same cable run. The amplifier can compensate for up to 15Ω per conductor with a current flow of 15mA, which is more than adequate for 150m of 0.25 mm² cable, longer lengths will require larger conductors.

For this reason Positek® recommends five wire connections for cable lengths exceeding 10 metres in 0.25 mm² cable to preserve the full accuracy of the sensor.

See illustrations below for examples of connecting a sensor to the galvanic isolation amplifier.

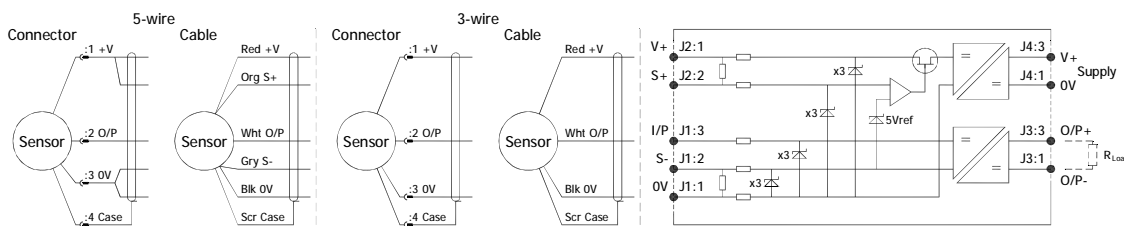

Cable Length (metres)	Up to 150	150 - 300	300 - 450	450 - 600	600 - 900	900 - 1000
Cross Section (mm ²)	0.25	0.5	0.75	1.0	1.5	2.0

The table above shows recommended conductor sizes with respect to cable length for both three and five wire connections, based on copper conductors. Three wire connections will introduce a gain reduction of 5% and a ±1% temperature dependence of gain over the range -40°C to +80°C for the cable temperature. (i.e. about -150 ppm/°C for the maximum lengths shown and less pro rata for shorter lengths.)

It should be noted that the maximum cable length, as specified in the sensor certification, takes precedence and must not be exceeded.

Positek® sensors are supplied with three core 0.25 mm² cable as standard, however five core 0.25 mm² cable can be supplied on request. The galvanic isolation amplifier is available as;

- G005-*** for 'G' and 'H' prefix sensors
- X005-*** for 'E', 'M' and 'X' prefix sensors

[†] $R = \rho L/A$ ρ is the resistivity of the conductor (Ωm) L is the length of conductor (m) A is the conductor cross-sectional area (m²).

[‡] It is presumed that direct current flow is uniform across the cross-section of the wire, the galvanic isolation amplifier and sensor are a dc system.

Intrinsically Safe - Gas/Vapour Atmospheres

LIPS® SERIES G111 Rugged Stand-Alone Linear Position Sensor

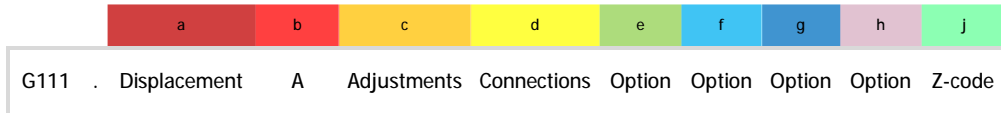

a Displacement (mm)		Value
Displacement in mm	e.g. 0 - 254 mm	254
b Output		
Supply V dc V _s (tolerance)	Output	Code
+5V (4.5 - 5.5V)	0.5 - 4.5V (ratiometric with supply)	A
c Calibration Adjustments		Code
Accessible - default [†]	[†] Axial body style only. Radial body style sealed by default.	blank
Sealed		Y
d Connections Cable* or Connector		Code
Cable Gland - Radial	IP67 Pg9 - 3-core cable	Ixx
Cable Gland - Radial	IP67 Pg9 - 5-core cable	IQxx
Connector - Axial	IP65 DIN 43650 'C'	J
Connector - Radial	IP67 M12 IEC 60947-5-2	K
Cable Gland - Axial	IP67 M12 - 3-core cable	Lxx
Cable Gland - Axial	IP67 M12 - 5-core cable	LQxx
Cable Gland - Axial	IP67 Short - 3-core cable	Mxx
Cable Gland - Axial	IP67 Short - 5-core cable	MQxx
<small>*Supplied with 50 cm as standard, specify required cable length specified in cm. e.g. L2000 specifies cable gland with 20 metres of cable. Nb: restricted cable pull strength.</small>		
e Body Fittings		Code
None - default		blank
M8 Rod-eye Bearing	Radial body style only	N
Body Clamps - 1 pair		P
Body Clamps - 2 pairs		P2
f Sprung Push Rod		Code
None - default		blank
Spring Extend	Up to 300mm displacement.	R
Spring Retract	Captive push rod only.	S
g Push Rod Fittings		Code
None - default		blank
Dome end	Female Thread M8x1.25x12 deep	T
M8 Rod-eye Bearing		U
h Push Rod Options		Code
Captive - default		blank
Non-captive		V

j Z-code	Code
Calibration to suit G005 - Default	Z000
Connector IP67 M12 IEC 60947-5-2 must have options 'Y' & 'J'	Z600
Connector IP67 M12 IEC 60947-5-2 must have option 'J'	Z601
≤± 0.1% @20°C Independent Linearity displacement between 10mm & 400mm only!	Z650
Connector with cable option 'J', 'JQ', 'K' or 'KQ' with length required in cm	Z999

Note!

All Intrinsically Safe (IS) sensors must have a Z-code suffix.
IS sensors must be used in conjunction with a Galvanic Isolation Amplifier - See G005 for Output options.

Generic Installation Information

G SERIES SENSORS

INTRINSICALLY SAFE FOR HAZARDOUS GAS/VAPOUR ATMOSPHERES

CSA Qualified Intrinsically Safe Device Certificate number 13.2588225		Class I, Zone 0 Ex ia IIC T4 (Ta = -40°C to +80°C) AEx ia IIC T4 / Ex ia IIC T4(Ta = -40°C to +80°C)	
Electronics Option	Output Description:	Supply Voltage: V _s (tolerance)	Load resistance:
A	0.5 - 4.5V (ratiometric with supply)	+5V (4.5 - 5.5V)	5kΩ min

Connector Pin Layout:

DIN 43650 C



IEC 60947-5-2

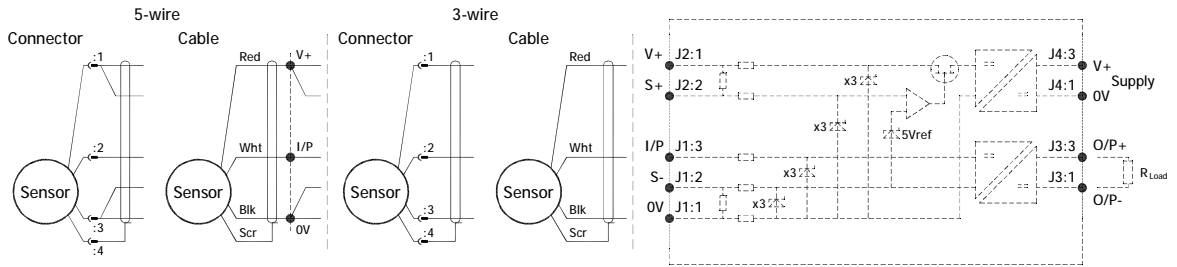

Putting Into Service:

The sensor must be used with a galvanic isolation barrier designed to supply the sensor with a nominal 5V and to transmit the sensor output to a safe area. The barrier parameters must not exceed:-

$$\begin{array}{lll}
 U_i = 11.4V & I_i = 0.20A & P_i = 0.51W \\
 C_i = 1.36\mu F^* & L_i = 710\mu H^* & \text{(with maximum length integral cable)} \\
 C_i = 1.16\mu F & L_i = 50\mu H & \text{(without integral cable)}
 \end{array}$$

*Figures for 1km cable where: C_i = 200pF/m & L_i = 660nH/m

The sensor is certified to be used with up to 1000m of cable, cable characteristics must not exceed:-

$$\begin{array}{l}
 \text{Capacitance: } \leq 200 \text{ pF/m for max. total of: } 200 \text{ nF} \\
 \text{Inductance: } \leq 660 \text{ nH/m for max. total of: } 660 \mu H
 \end{array}$$

Use:

The sensor is designed to measure Linear or rotary displacement and provide an analogue output signal.

Assembly and Dismantling:

The unit is not to be serviced or dismantled and re-assembled by the user.

WARNING: Substitution of components may impair intrinsic safety
AVERTISSEMENT: La substitution de composants peut altérer la sécurité intrinsèque

Maintenance:

No maintenance is required.



Installation Information

LIPS[®] G111 RUGGED STAND-ALONE LINEAR POSITION SENSOR

INTRINSICALLY SAFE FOR HAZARDOUS GAS/VAPOUR ATMOSPHERES

Connector Pin Layout:

DIN 43650 C



IEC 60947-5-2

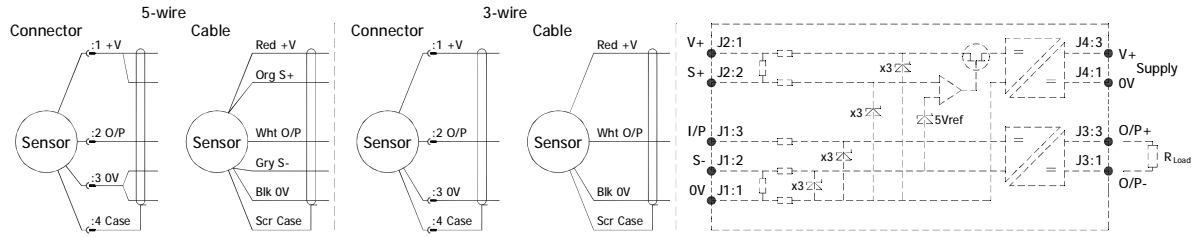

Approval only applies to specified ambient temperature range and atmospheric conditions in the range: 0.80 to 1.10 Bar, oxygen ≤ 21%.

The G111 is available with the following connections:-

IP65	DIN 43650 C Connector	Axial	Option 'J'
IP67	IEC 60947-5-2 Connector	Radial	Option 'K'
IP67	Cable gland with cable	Axial or Radial	Options 'Lxx', 'LQxx', 'Mxx', 'MQxx', 'Ixx' or 'IOxx'

The performance of the sensor may be affected by voltage drops associated with long cable lengths; For cable lengths exceeding 10 metres a five wire connection is recommended to eliminate errors introduced by cable resistance and associated temperature coefficients.

Cable Up to 150m of 0.2 mm², screened, PUR jacket; 3 core cable 4 mm dia. black, 5 core cable 4.6 mm dia. Blue.

N.b. sensors supplied with cable, the free end must be appropriately terminated.

Warning - The M12 IEC 60947 connector may be rotated for purposes of convenient orientation of the connector and cable, however rotating the connector more than one complete revolution is not recommended.

Repeated rotation of the connector will damage the internal wiring!

Gain and Offset Adjustment: (Where accessible - Typically ± 10% Min available)

To adjust the gain or offset use a small potentiometer adjuster or screwdriver 2mm across. Do not apply too much force on the potentiometers.

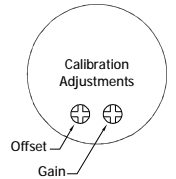

Mechanical Mounting: Mounting: Depending on options; Body can be mounted by M8 rod eye or by clamping the sensor body - body clamps are available, if not already ordered. Target by M8x1.25 female thread or M8 rod eye. It is assumed that the sensor and target mounting points share a common earth.

Output Characteristic: Target is extended 7 mm from end of body at start of normal travel. The output increases as the target extends from the sensor body, the calibrated stroke is between 5 mm and 800 mm.

Incorrect Connection Protection levels: Not protected – the sensor is not protected against either reverse polarity or over-voltage. The risk of damage should be minimal where the supply current is limited to less than 50mA.

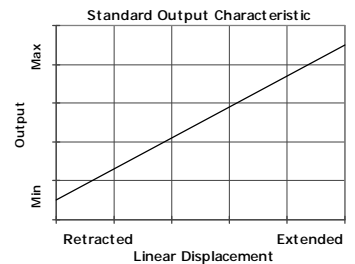

For further information please contact:
 www.positek.com sales@positek.com
 Tel: +44(0)1242 820027 fax: +44(0)1242 820615
 Positek Ltd, Andoversford Industrial Estate, Cheltenham GL54 4LB. U.K.

