

2 OFF 3.2 SLOTS ±15° ON 25.0 PCD. (SYMMETRICAL)

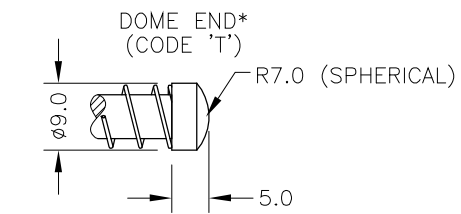
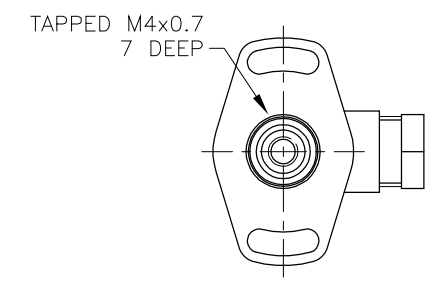
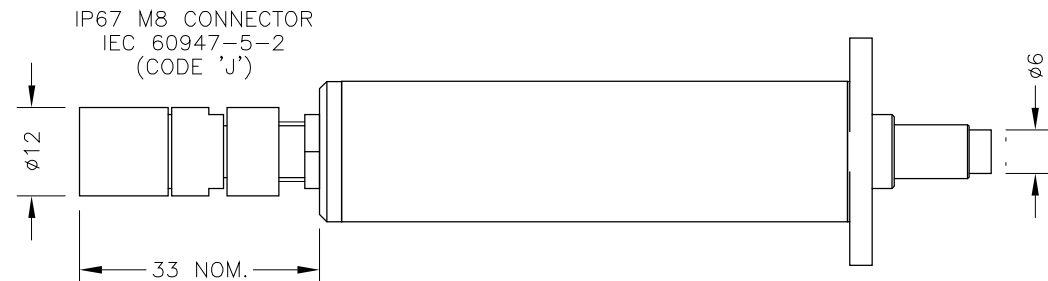
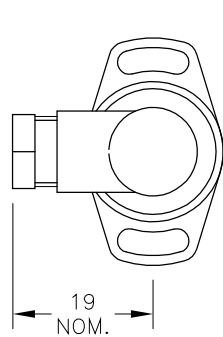
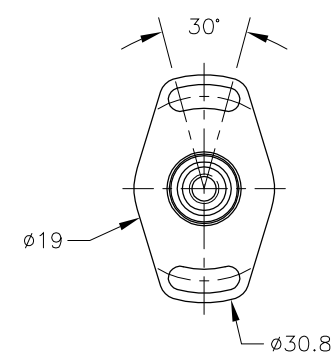

NOTE: SENSORS WITH TRAVEL UP TO 50mm ARE MADE IN STANDARD LENGTHS.

TRAVEL: (mm)	BODY LENGTH: (mm)
0-2 TO 0-10	78.0
0-11 TO 0-20	88.0
0-21 TO 0-30	98.0
0-31 TO 0-50	118.0

ELECTRICAL OPTIONS/ SPECIFICATIONS

OUTPUT	SUPPLY	
0.5 TO 4.5V RATIOMETRIC	5V	
SUPPLY CURRENT 12mA TYP. 20mA MAX.		
CABLE: 0.2mm <sup>2</sup> , O/A SCREEN, PUR JACKET – SUPPLIED WITH 50cm OR REQUIRED LENGTH IN cm (15000cm MAX).		
STANDARD 3-CORE: JACKET Ø4mm BLACK	e.g. 'L50'	
OPTIONAL 5-CORE: JACKET Ø4.6mm BLUE	e.g. 'LQ50'	
CABLE/CONNECTOR* CONNECTIONS;		
3 CORE	5 CORE	CONNECTOR
RED	RED	:1 +Ve
-	ORG	:1 +SENSE (5-WIRE ONLY)
BLACK	BLACK	:3 0V
-	GRY	:3 -SENSE (5-WIRE ONLY)
WHITE	WHITE	:2 OUTPUT
SCREEN	SCREEN	:4 BODY

\*CONNECTORS; MAXIMUM CONDUCTOR CROSS SECTION 0.25mm<sup>2</sup>  
RANGE OF DISPLACEMENT FROM 0-2mm TO 0-50mm e.g.36, IN INCREMENTS OF 1mm.

BODY MATERIAL:- STAINLESS STEEL.  
FLANGE BASE MATERIAL:- STAINLESS STEEL

FURTHER OPTIONS:  
SINGLE PAIR OF BODY CLAMPS (CODE 'P')  
SPRUNG PLUNGER, TO EXTENDED POSITION (CODE 'R')  
DOME END (CODE 'T') IN CONJUNCTION WITH SPRUNG PLUNGER (CODE 'R')\*

PLUNGER FREE (CODE 'V')  
N.b. NOT AVAILABLE WITH SPRUNG OPTIONS.

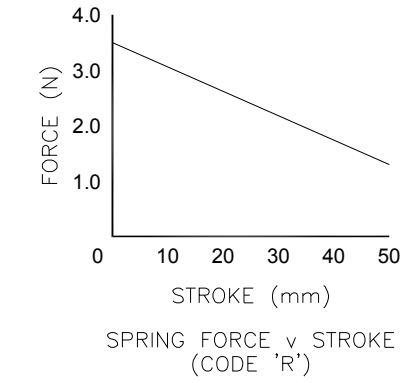

NOTE:- READ INSTALLATION SHEET H000-19 FOR FULL INSTRUCTIONS FOR USE.

**CSA APPROVED TO**  
**Class I Zone 0**  
**Ex/AEx ia IIC T4 (Ta= -40 to 80°C)**  
**Ex iaD 20 T93°C(Ta= -40 to 80°C)**  
**Ui 11.4V, Ii 0.2A, Pi 0.51W**

APPROVED FOR USE IN CONJUNCTION WITH A GALVANICALLY ISOLATED BARRIER.

NOTE: APPROVAL ONLY APPLIES AT NORMAL ATMOSPHERIC PRESSURE!

A	FIRST ISSUE	PDM
B	STROKE 2-10 WAS 10 - RAN1063, OPTION 'J'	PDM
C	ADDED - RAN1068.	PDM
D	5-CORE OPTION ADDED ~ RAN1102	PDM
	RANGE NOTE AMENDED ~ RAN1200	PDM

**CE** THE PLUNGER RETRACTS 8mm FROM START OF CALIBRATED TRAVEL (2mm FOR SPRUNG VERSIONS) AND EXTENDS 11mm\* BEYOND END OF MECHANICAL TRAVEL. \*DOES NOT INCLUDE DIFFERENCE BETWEEN CALIBRATED AND MECHANICAL TRAVEL, DIMENSIONS ARE NOMINAL. 'V' CODED PLUNGER WILL DEPART SENSOR BODY.

DRAWINGS NOT TO BE CHANGED WITHOUT REFERENCE TO THE CHANGE PROCEDURE. CHANGES TO PARTS USED IN INTRINSICALLY SAFE PRODUCT MUST BE APPROVED BY THE AUTHORISED PERSON  
THIS IS AN UNCONTROLLED PRINT AND WILL NOT BE UPDATED.



A	21/11/13		CHECKED BY	X ±0.4
B	25/11/15		RDS	X.X ±0.2
C	26/04/17			X.XX ±0.1
D	06/09/17			DIMS mm
DESCRIPTION		H118 INTRINSICALLY SAFE SHORT STROKE SLIM-LINE LINEAR POSITION SENSOR		
SCALE	10mm	DRAWING NUMBER	H118-11	REV D
		SHEET 1 OF 1		

# LIPS<sup>®</sup> H118 SHORT STROKE SLIM-LINE LINEAR POSITION SENSOR

INTRINSICALLY SAFE FOR HAZARDOUS DUST ATMOSPHERES

- Intrinsically safe for Gas and Dust to: Class I, Zone 0 Ex ia/ AEx ia
- Non-contacting inductive technology to eliminate wear
- Travel set to customer's requirement
- Compact 19 mm diameter body
- High durability and reliability
- High accuracy and stability
- Sealing to IP67

As a leading designer and manufacturer of linear, rotary, tilt and intrinsically safe position sensors, Positek<sup>®</sup> has the expertise to supply a sensor to suit a wide variety of applications.

Our intrinsically safe H118 LIPS<sup>®</sup> (Linear Inductive Position Sensor) incorporates electronics system EX06 which is CSA approved for use in potentially explosive gas/vapour and dust atmospheres. The H118 is designed for a wide range of industrial applications and is ideal for OEMs seeking good sensor performance in situations where a small diameter, short-bodied sensor is required for operation in hazardous areas. The unit is compact and space-efficient, being responsive along almost its entire length, and like all Positek<sup>®</sup> sensors provides a linear output proportional to travel. Each unit is supplied with the output calibrated to the travel required by the customer, from 2 to 50mm and with full EMC protection built in.

Overall performance, repeatability and stability are outstanding over a wide temperature range.

The sensor has a compact 19mm diameter stainless steel body, is easy to install and set up. The stainless steel mounting flange has two 3.2 mm by 30 degree wide slots on a 25 mm pitch. The stainless steel plunger can be supplied free or captive, with female M4 thread, or spring-loaded with a ball end. The H118 also offers a range of mechanical options, environmental sealing is to IP67.



## SPECIFICATION

<b>Dimensions</b>	
Body diameter	19 mm
Body Length:	Dependant on calibrated travel
Calibrated travel	
2 mm to 10 mm	78 mm
11 mm to 20 mm	88 mm
21 mm to 30 mm	98 mm
31 mm to 50 mm	118 mm
Plunger	Ø 6mm
For full mechanical details see	drawing H118-11
<b>Power Supply</b>	+5V dc nom. ± 0.5V, 10mA typ 20mA max
<b>Output Signal</b>	0.5-4.5V dc ratiometric, Load: 5kΩ min.
<b>Independent Linearity</b>	≤ ± 0.25% FSO @ 20°C ≤ ± 0.1% FSO @ 20°C available upon request.
*Sensors with calibrated travel of 10 mm and above.	
<b>Temperature Coefficients</b>	< ± 0.01%/°C Gain & < ± 0.01%FS/°C Offset
<b>Frequency Response</b>	> 10 kHz (-3dB)
<b>Resolution</b>	Infinite
<b>Noise</b>	< 0.02% FSO
<b>Intrinsic Safety</b>	Class I, Zone 0 Ex ia IIC T4 (Ta= -40°C to 80°C) AEx ia IIC T4 (Ta= -40°C to 80°C) AEx ia D IIIC T93°C (Ta = -40°C to +80°C)
Approval only applies to the specified ambient temperature range and atmospheric conditions in the range 0.80 to 1.10 Bar, oxygen ≤ 21%	
<b>Sensor Input Parameters</b>	Ui: 11.4V, Ii: 0.20A, Pi: 0.51W.
(connector option/s)	Ci: 1.16µF, Li: 50µH
(cable option/s)	Ci: 1.36µF, Li: 710µH with 1km max. cable
<b>Environmental Temperature Limits</b>	
Operating	-40°C to +80°C
Storage	-40°C to +125°C
<b>Sealing</b>	IP67
<b>EMC Performance</b>	EN 61000-6-2, EN 61000-6-3
<b>Vibration</b>	IEC 68-2-6: 10 g
<b>Shock</b>	IEC 68-2-29: 40 g
<b>MTBF</b>	350,000 hrs 40°C Gf
<b>Drawing List</b>	
H118-11	Sensor Outline
Drawings, in AutoCAD <sup>®</sup> dwg or dxf format, available on request.	

Do you need a position sensor made to order to suit a particular installation requirement or specification? We'll be happy to modify any of our designs to suit your needs - please contact us with your requirements.

# LIPS<sup>®</sup> H118 SHORT STROKE SLIM-LINE LINEAR POSITION SENSOR

## INTRINSICALLY SAFE FOR HAZARDOUS DUST ATMOSPHERES

Intrinsically safe equipment is defined as "equipment which is incapable of releasing sufficient electrical or thermal energy under normal or abnormal conditions to cause ignition of a specific hazardous atmosphere mixture in its most easily ignited concentration."

CSA approved to;

- Class I, Zone 0
- Ex ia IIC T4 (Ta = -40°C to +80°C)
- AEx ia IIC T4 (Ta = -40°C to +80°C)
- AEx ia D IIIC T93°C (Ta = -40°C to +80°C)

Designates the sensor as belonging to; Class I, Zone 0: can be used in areas with continuous, long or frequent periods of exposure to hazardous gas or dust.

Gas:

Protection class ia IIC, denotes intrinsically safe for Zones 0, 1 & 2 and IIA, IIB and IIC explosive gases.

Temperature class T4: maximum sensor surface temperature under fault conditions 135°C.

Dust:

T93°C: maximum sensor surface temperature under fault conditions 93°C.

Ambient temperature range extended to -40°C to +80°C.

It is imperative Positek<sup>®</sup> intrinsically safe sensors be used in conjunction with a galvanic barrier to meet the requirements of the product certification. The Positek G005 Galvanic Isolation Amplifier is purpose made for Positek IS sensors making it the perfect choice. Refer to the G005 datasheet for product specification and output configuration options.

### Safety Parameters:-

- Ui: 11.4V, Ii: 0.20A, Pi: 0.51W
- Ci = 1.36µF\*      Li = 710µH\* (cable option/s)
- Ci = 1.16µF      Li = 50µH (connector option/s)

\*Figures for 1km cable where: Ci = 200pF/m & Li = 660nH/m

Sensors can be installed with a maximum of 1000m of cable.

Cable characteristics must not exceed:-

Capacitance: ≤ 200 pF/m for max. total of: 200 nF.

Inductance: ≤ 660 nH/m for max. total of: 660 µH

For cable lengths exceeding 10 metres a five wire connection is recommended to eliminate errors introduced by cable resistance and associated temperature coefficients.

CSA approved sensors suitable for gas (G series) applications, are also available from Positek.

### TABLE OF OPTIONS

**CALIBRATED TRAVEL:** Factory set to any length from 0-2mm to 0-50mm (e.g. 36mm).

#### ELECTRICAL INTERFACE OPTIONS

The Positek<sup>®</sup> G005 Galvanic Isolation Amplifier is available with the following output options;

- Standard: 0.5 - 9.5V or 4 - 20mA.
- Reverse: 9.5 - 0.5V or 20 - 4mA.

#### CONNECTOR/CABLE OPTIONS

- Connector - M8 IEC 60947-5-2 IP67
- Cable<sup>†</sup> with M8 gland IP67

<sup>†</sup>Three core (black jacket) or five core (blue jacket) cable options available. Cable length >50 cm – please specify length in cm up to 15000 cm max.

We recommend all customers refer to the 3 or 5-Wire Mode Connection page.

**PUSH ROD OPTIONS:** – standard retained with M4x0.7 female thread Sprung loaded (spring supplied loose), Dome end (sprung loaded) or Free

Output Characteristic - Standard

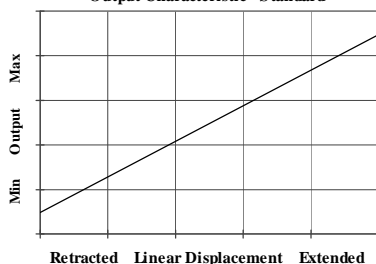

For further information please contact:

www.positek.com sales@positek.com

Tel: +44(0)1242 820027 fax: +44(0)1242 820615

Positek Ltd, Andoversford Industrial Estate, Cheltenham GL54 4LB U.K.



# Three or Five-Wire Mode Connection FOR INTRINSICALLY SAFE SENSORS IN HAZARDOUS ATMOSPHERES

The aim of this document is to help readers who do not understand what is meant by three or five wire modes of connection between the galvanic isolation amplifier and sensor, and the factors behind them. It is by no means an in-depth technical analysis of the subject.

Whether opting for a pre-wired Positek® Intrinsically Safe sensor or one with a connector, choosing the right mode of connection and cable to suit the application requires careful consideration.

Interconnecting cables are not perfect conductors and offer resistance to current flow, the magnitude of resistance<sup>†</sup> depends on conductors resistivity, which changes with temperature, cross sectional area<sup>‡</sup> and length. If the voltage were to be measured at both ends of a length of wire it would be found they are different, this is known as volts drop. Volts drop changes with current flow and can be calculated using Ohm's law, it should be noted that volts drop occurs in both positive and negative conductors. The effects of volts drop can be reduced by increasing the conductors cross sectional area, this does not however eliminate the effects due to temperature variation. There are instances where large cross-section cables are not practical; for example most standard industrial connectors of the type used for sensors have a maximum conductor capacity of 0.75mm<sup>2</sup>, copper prices and ease of installation are other considerations.

This is important because the effects of volts drop can significantly alter the perceived accuracy of the sensor which is ratiometric i.e. the output signal is directly affected by the voltage across the sensor. Changes in temperature will also be seen as gain variation in the sensor output.

**Three wire mode** connections are common and are suitable in most cases with short or moderate cable runs. Applications that do not require a high degree of accuracy but have cable runs, say in excess of 10m, volts drop can be reduced by introducing a terminal box close to the sensor and using a larger cross-section cable for a majority of the cable run. Sensors supplied with three core cable are calibrated with the cable fitted which largely eliminates errors due to conductor resistance at room temperature however, as mentioned above, small gain errors due to temperature fluctuations should be expected.

**Five wire mode** connections have significant benefits as losses in the positive and negative conductors are compensated for by the galvanic isolation amplifier which can 'sense' the voltage across the sensor and dynamically adjust the output voltage so that the voltage across the sensor is correct. The effects of cable resistance and associated temperature coefficients are eliminated allowing for smaller conductors than a three wire connection for the same cable run. The amplifier can compensate for up to 15Ω per conductor with a current flow of 15mA, which is more than adequate for 150m of 0.25 mm<sup>2</sup> cable, longer lengths will require larger conductors.

For this reason Positek® recommends five wire connections for cable lengths exceeding 10 metres in 0.25 mm<sup>2</sup> cable to preserve the full accuracy of the sensor.

See illustrations below for examples of connecting a sensor to the galvanic isolation amplifier.

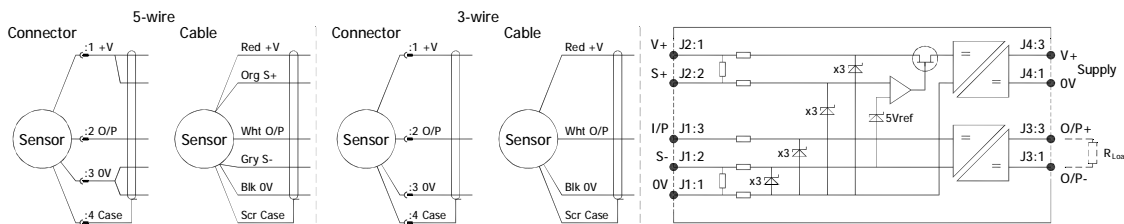

Cable Length (metres)	Up to 150	150 - 300	300 - 450	450 - 600	600 - 900	900 - 1000
Cross Section (mm <sup>2</sup> )	0.25	0.5	0.75	1.0	1.5	2.0

The table above shows recommended conductor sizes with respect to cable length for both three and five wire connections, based on copper conductors. Three wire connections will introduce a gain reduction of 5% and a ±1% temperature dependence of gain over the range -40°C to +80°C for the cable temperature. (i.e. about -150 ppm/°C for the maximum lengths shown and less pro rata for shorter lengths.)

It should be noted that the maximum cable length, as specified in the sensor certification, takes precedence and must not be exceeded.

Positek® sensors are supplied with three core 0.25 mm<sup>2</sup> cable as standard, however five core 0.25 mm<sup>2</sup> cable can be supplied on request. The galvanic isolation amplifier is available as;

G005-\*\*\* for 'G' and 'H' prefix sensors  
 X005-\*\*\* for 'E', 'M' and 'X' prefix sensors

<sup>†</sup>  $R = \rho L/A$   $\rho$  is the resistivity of the conductor ( $\Omega m$ )  $L$  is the length of conductor (m)  $A$  is the conductor cross-sectional area (m<sup>2</sup>).

<sup>‡</sup> It is presumed that direct current flow is uniform across the cross-section of the wire, the galvanic isolation amplifier and sensor are a dc system.

# Intrinsically Safe - Dust Atmospheres

## LIPS® SERIES H118 Short Stroke Slim-Line Position Sensor

a	b	c	d	e	f	g	h	j		
H118	.	Displacement	A	Connections	N	Option	Option	Option	Option	Z-code

a Displacement (mm)		Value
Displacement in mm	e.g. 0 - 22 mm	22
b Output		
Supply V dc V <sub>s</sub> (tolerance)	Output	Code
+5V (4.5 - 5.5V)	0.5 - 4.5V (ratiometric with supply)	A
c Connections Cable* or Connector		Code
Connector	IP67 M8 IEC 60947-5-2	J
Cable Gland	IP67 M8 - 3-core cable	Lxx
Cable Gland	IP67 M8 - 5-core cable	LQxx
<small>*Supplied with 50 cm as standard, specify required cable length specified in cm. e.g. L2000 specifies cable gland with 20 metres of cable. Nb: restricted cable pull strength.</small>		
d Housing		Code
Flange Mount		N
e Body Fittings		Code
None - default		blank
Body Clamps - 1 pair		P
f Sprung Plunger		Code
None - default		blank
Spring Extend	Captive plunger only.	R
g Plunger Fittings		Code
None - default	Female Thread M4x0.7x7 deep	blank
Dome end	Required for option 'R'	T
h Plunger Options		Code
Captive - default	Plunger is retained	blank
Non-captive	Plunger can depart body	V
j Z-code		Code
Calibration to suit G005 - Default		Z000
$\leq \pm 0.1\%$ @20°C Independent Linearity displacement between 10mm & 50mm only!		Z650
Connector with cable option 'J' with length required in cm i.e. J100 specifies connector with 100cm of cable. n.b. 5-core cable option not available.		Z999

### Note!

All Intrinsically Safe (IS) sensors must have a Z-code suffix.

IS sensors must be used in conjunction with a Galvanic Isolation Amplifier - See G005 for Output options.

# Generic Installation Information

## H SERIES SENSORS

### INTRINSICALLY SAFE FOR HAZARDOUS GAS/VAPOUR & DUST ATMOSPHERES

CSA Qualified Intrinsically Safe Device Certificate number 13.2588225		Class I, Zone 0 Ex ia IIC T4 (Ta = -40°C to +80°C) AEx ia IIC T4 / Ex ia IIC T4 (Ta = -40°C to +80°C) AEx ia D IIC T93°C (Ta = -40°C to +80°C)	
Electronics Option	Output Description:	Supply Voltage: V <sub>s</sub> (tolerance)	Load resistance:
A	0.5 - 4.5V (ratiometric with supply)	+5V (4.5 - 5.5V)	5kΩ min

**Connector Pin Layout:**  
DIN 43650 C



IEC 60947-5-2

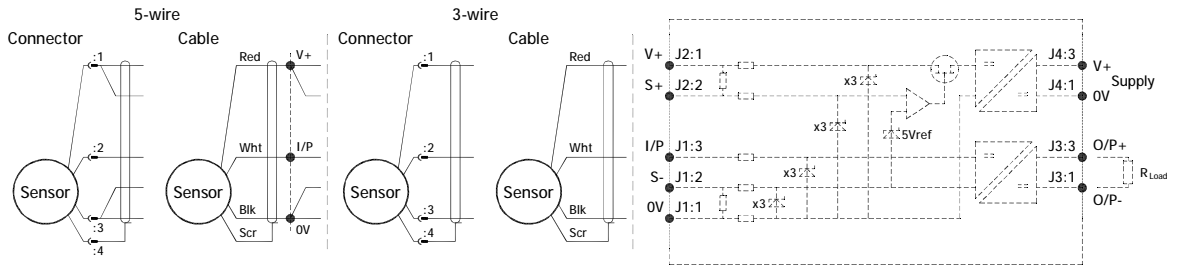

**Putting Into Service:**

The sensor must be used with a galvanic isolation barrier designed to supply the sensor with a nominal 5V and to transmit the sensor output to a safe area. The barrier parameters must not exceed:-

$U_i = 11.4V$	$I_i = 0.20A$	$P_i = 0.51W$
$C_i = 1.36\mu F^*$	$L_i = 710\mu H^*$	(with maximum length integral cable)
$C_i = 1.16\mu F$	$L_i = 50\mu H$	(without integral cable)

\*Figures for 1km cable where:  $C_i = 200pF/m$  &  $L_i = 660nH/m$

The sensor is certified to be used with up to 1000m of cable, cable characteristics must not exceed:-

Capacitance:  $\leq 200 pF/m$  for max. total of: 200 nF  
 Inductance:  $\leq 660 nH/m$  for max. total of: 660  $\mu H$

**Use:**

The sensor is designed to measure Linear or rotary displacement and provide an analogue output signal.

**Assembly and Dismantling:**

The unit is not to be serviced or dismantled and re-assembled by the user.

WARNING: Substitution of components may impair intrinsic safety  
 AVERTISSEMENT: La substitution de composants peut altérer la sécurité intrinsèque

**Maintenance:**

Accumulated dust layer must not exceed a depth of 50mm.



# Installation Information

## LIPS<sup>®</sup> H118 SHORT STROKE SLIM-LINE LINEAR POSITION SENSOR

### INTRINSICALLY SAFE FOR HAZARDOUS DUST ATMOSPHERES

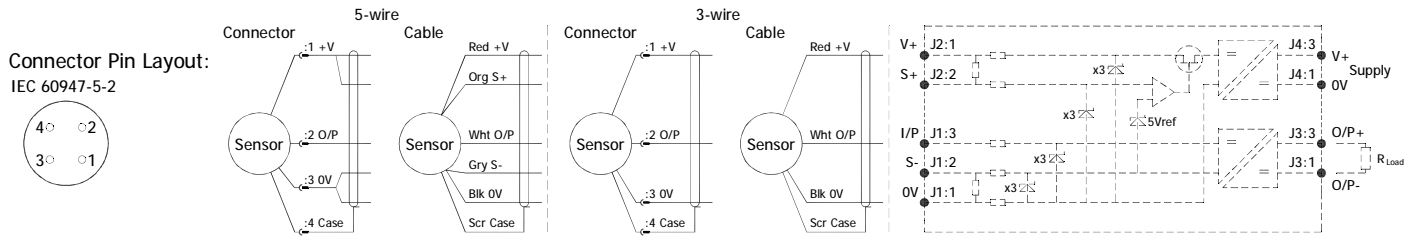

Approval only applies to specified ambient temperature range and atmospheric conditions in the range: 0.80 to 1.10 Bar, oxygen  $\leq$  21%.

**The H118 is available with the following connections:-**

- |      |                         |       |                         |
|------|-------------------------|-------|-------------------------|
| IP67 | IEC 60947-5-2 Connector | Axial | Option 'J'              |
| IP67 | Cable gland with cable  | Axial | Options 'Lxx' or 'LQxx' |

The performance of the sensor may be affected by voltage drops associated with long cable lengths; For cable lengths exceeding 10 metres a five wire connection is recommended to eliminate errors introduced by cable resistance and associated temperature coefficients.

Cable Up to 150m of 0.2 mm<sup>2</sup>, screened, PUR jacket; 3 core cable 4 mm dia. black, 5 core cable 4.6 mm dia. Blue.

N.b. sensors supplied with cable, the free end must be appropriately terminated.

**Mechanical Mounting:** Via the two slots in the flange, the slots are 3.2 mm by 30 degrees wide on a 25 mm pitch.

**Output Characteristic:** Plunger extended 16 mm\* from mounting face at start of normal travel.

\*Note: where dome end option is fitted add 5 mm.  
 The output increases as the plunger extends from the sensor body, the calibrated stroke is between 2 mm and 50 mm.

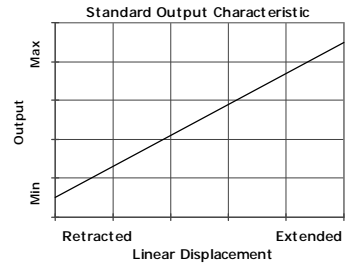

**Incorrect Connection Protection levels: Not protected** – the sensor is not protected against either reverse polarity or over-voltage. The risk of damage should be minimal where the supply current is limited to less than 50mA.