

GAIN AND OFFSET ADJUSTMENTS SEALED (CODE 'Y')

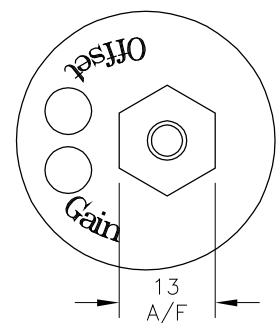

IP67 SHORT CABLE GLAND (CODE 'Mxx')

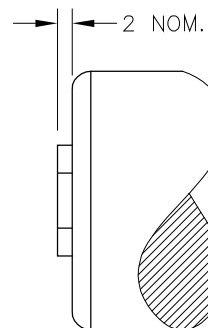

NOTE: SENSORS WITH TRAVEL UP TO 50mm ARE MADE IN STANDARD LENGTHS.

TRAVEL: (mm)	BODY LENGTH: (mm)
CALIBRATED	MECHANICAL 'X' STANDARD 'Y' FLANGE
0-2 TO 0-10	10 65.0 81.3
0-11 TO 0-20	20 75.0 91.3
0-21 TO 0-30	30 85.0 101.3
0-31 TO 0-50	50 105.0 121.3

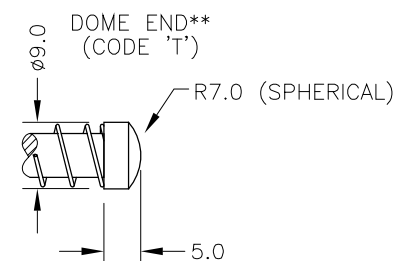

ELECTRICAL OPTIONS/ SPECIFICATIONS

OUTPUT OPTION	OUTPUT	SUPPLY	
A	0.5 TO 4.5V RATIOMETRIC	5V	STANDARD
B	±5V	±15V	
C	0.5 TO 9.5V	24V	
D	±10V	±15V	BUFFERED
E	0.5 TO 4.5V	24V	
F	SUPPLY CURRENT 12mA TYP. 20mA MAX.	24V	
G	4 TO 20mA 2-WIRE	24V	
H	4 TO 20mA 3-WIRE SINK	24V	
	4 TO 20mA 3-WIRE SOURCE	24V	

SINK VERSION OUTPUT COMPLIANCE 5-28V  
SOURCE VERSION DRIVE 300Ω MAX TO 0V

CABLE: 0.2mm<sup>2</sup>, O/A SCREEN, PUR JACKET - SUPPLIED WITH 50cm OR REQUIRED LENGTH IN cm. e.g. 'L50'

3-CORE: JACKET Ø4mm

4-CORE: JACKET Ø4.6mm

CABLE/CONNECTOR\* CONNECTIONS;

3 CORE 4 CORE CONNECTOR

RED	RED	:1	+Ve
BLACK	GREEN	:3	0V
	YELLOW	:4	-Ve - OPTIONS: B OR D
WHITE	BLUE	:2	OUTPUT
SCREEN	SCREEN	:4	BODY - OPTIONS: A, C, E-H

\*CONNECTORS; MAXIMUM CONDUCTOR CROSS SECTION 0.75mm<sup>2</sup>  
RANGE OF DISPLACEMENT FROM 0-2mm TO 0-50mm e.g.36, IN INCREMENTS OF 1mm.

BODY MATERIAL: STAINLESS STEEL.

FLANGE MATERIAL: ALUMINIUM (CODE 'N')

FURTHER OPTIONS:

SINGLE PAIR OF BODY CLAMPS (CODE 'P')

SPRUNG PLUNGER, TO EXTENDED POSITION (CODE 'R')

HOME END (CODE 'T') IN CONJUNCTION WITH SPRUNG

PLUNGER (CODE 'R')\*\*

PLUNGER FREE (CODE 'V')

N.b. NOT AVAILABLE WITH SPRUNG OPTIONS.

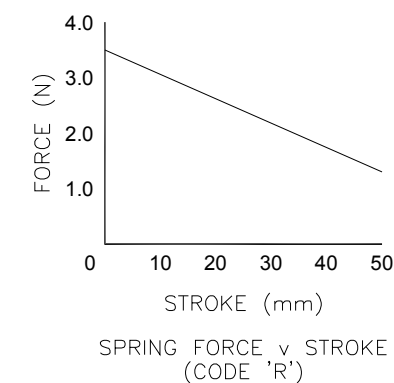

L	1.5-3.5N WAS 0.25-1.25N - RAN449.	PDM
M	CALIBRATION START MOVED -0.5 - RAN449	PDM
N	STROKE NOTES AMENDED.	PDM
O	STANDARD VERSION AMENDED - RAN467.	PDM
P	STROKE 2-10 WAS 10 - RAN1063	PDM
Q	RANGE NOTE AMENDED ~ RAN1200	PDM



THE PLUNGER RETRACTS 5mm FROM START OF CALIBRATED TRAVEL (2mm FOR SPRUNG VERSIONS) AND EXTENDS 9.5mm\* BEYOND END OF MECHANICAL TRAVEL. \*DOES NOT INCLUDE DIFFERENCE BETWEEN CALIBRATED AND MECHANICAL TRAVEL, DIMENSIONS ARE NOMINAL. 'V' CODED PLUNGER WILL DEPART SENSOR BODY.

DRAWINGS NOT TO BE CHANGED WITHOUT REFERENCE TO THE CHANGE PROCEDURE.  
CHANGES TO PARTS USED IN INTRINSICALLY SAFE PRODUCT MUST BE APPROVED BY THE AUTHORISED PERSON  
THIS IS AN UNCONTROLLED PRINT AND WILL NOT BE UPDATED.



L	21/10/13	CHECKED BY RDS	X	±0.4
M	23/10/13		X.X	±0.2
N	21/11/13		X.XX	±0.1
O	10/12/13	DESCRIPTION		
P	10/11/15	P103 LIPS SHORT STROKE		
Q	29/08/17	LINEAR POSITION SENSOR		
SCALE 10mm		DRAWING NUMBER	P103-11	REV Q
10mm		SHEET 1 OF 1		

# LIPS® P103 SHORT STROKE LINEAR POSITION SENSOR

Position feedback for industrial and scientific applications

- Non-contacting inductive technology to eliminate wear
- Travel set to customer's requirement
- Short body length
- High durability and reliability
- High accuracy and stability
- Sealing to IP65/IP67 as required



As a leading designer and manufacturer of linear, rotary, tilt and intrinsically safe position sensors, Positek® has the expertise to supply a sensor to suit a wide variety of applications.

Our P103 LIPS® (Linear Inductive Position Sensor) is an affordable, durable, accurate position sensor designed for a wide range of industrial applications. It is particularly suitable for OEMs seeking good sensor performance in situations where a short-bodied sensor is needed and cost is important. The unit is compact and space-efficient, being responsive along almost its entire length, and like all Positek® sensors provides a linear output proportional to travel. Each unit is supplied with the output calibrated to the travel required by the customer, from 2 to 50mm and with full EMC protection built in.

Overall performance, repeatability and stability are outstanding over a wide temperature range.

The sensor has a rugged stainless steel body and plunger. It is easy to install and set up, mounting options include flange and body clamps. The plunger can be supplied free or captive, with female M4 thread, or spring-loaded with a ball end. The P103 also offers a wide range of mechanical and electrical options, environmental sealing is to IP65 or IP67 depending on selected cable or connector options.

## SPECIFICATION

<b>Dimensions</b>	
Body diameter	35 mm
Body Length:	Dependant on calibrated travel & mounting option
Calibrated Travel	Standard Flange mounted
2 mm to 10 mm	65 mm 81.3 mm
11 mm to 20 mm	75 mm 91.3 mm
21 mm to 30 mm	85 mm 101.3 mm
31 mm to 50 mm	105 mm 121.3 mm
Plunger	Ø 6mm
For full mechanical details see	drawing P103-11
<b>Power Supply</b>	+5V dc nom. ± 0.5V, 10mA typ 20mA max
<b>Output Signal</b>	0.5-4.5V dc ratiometric, Load: 5kΩ min.
<b>Independent Linearity</b>	≤ ± 0.25% FSO @ 20°C ≤ ± 0.1% FSO @ 20°C available upon request.
*Sensors with calibrated travel of 10 mm and above.	
<b>Temperature Coefficients</b>	< ± 0.01%/°C Gain & < ± 0.01%FS/°C Offset
<b>Frequency Response</b>	> 10 kHz (-3dB) > 300 Hz (-3dB) 2 wire 4 to 20 mA
<b>Resolution</b>	Infinite
<b>Noise</b>	< 0.02% FSO
<b>Environmental Temperature Limits</b>	
Operating	-40°C to +125°C standard -20°C to +85°C buffered -40°C to +125°C
Storage	-40°C to +125°C
<b>Sealing</b>	IP65/IP67 depending on connector / cable option
<b>EMC Performance</b>	EN 61000-6-2, EN 61000-6-3
<b>Vibration</b>	IEC 68-2-6: 10 g
<b>Shock</b>	IEC 68-2-29: 40 g
<b>MTBF</b>	350,000 hrs 40°C Gf
<b>Drawing List</b>	
P103-11	Sensor Outline
Drawings, in AutoCAD® dwg or dxf format, available on request.	

Do you need a position sensor made to order to suit a particular installation requirement or specification? We'll be happy to modify any of our designs to suit your needs - please contact us with your requirements.

# LIPS<sup>®</sup> P103 SHORT STROKE LINEAR POSITION SENSOR

Position feedback for industrial and scientific applications

## How Positek's PIPS<sup>®</sup> technology eliminates wear for longer life

Positek's PIPS<sup>®</sup> technology (Positek Inductive Position Sensor) is a major advance in displacement sensor design. PIPS<sup>®</sup>-based displacement transducers have the simplicity of a potentiometer with the life of an LVDT/RVDT.

PIPS<sup>®</sup> technology combines the best in fundamental inductive principles with advanced micro-electronic integrated circuit technology. A PIPS<sup>®</sup> sensor, based on simple inductive coils using Positek's ASIC control technology, directly measures absolute position giving a DC analogue output signal. Because there is no contact between moving electrical components, reliability is high and wear is eliminated for an exceptionally long life.

PIPS<sup>®</sup> overcomes the drawbacks of LVDT technology – bulky coils, poor length-to-stroke ratio and the need for special magnetic materials. It requires no separate signal conditioning.

Our LIPS<sup>®</sup> range are linear sensors, while RIPS<sup>®</sup> are rotary units and TIPS<sup>®</sup> are for detecting tilt position. Ask us for a full technical explanation of PIPS<sup>®</sup> technology.

We also offer a range of ATEX-qualified intrinsically-safe sensors.

## TABLE OF OPTIONS

**CALIBRATED TRAVEL:** Factory set to any length from 0-2mm to 0-50mm (e.g. 36mm).

### ELECTRICAL INTERFACE OPTIONS

OUTPUT SIGNAL	SUPPLY INPUT	OUTPUT LOAD
Standard: 0.5-4.5V dc ratiometric	+5V dc nom. ± 0.5V.	5kΩ min.
Buffered: 0.5-4.5V dc	+24V dc nom. + 9-28V.	5kΩ min.
±5V dc	±15V dc nom. ± 9-28V.	5kΩ min.
0.5-9.5V dc	+24V dc nom. + 13-28V.	5kΩ min.
±10V dc	±15 V dc nom. ± 13.5-28V.	5kΩ min.
Supply Current	10mA typical, 20mA maximum.	
4-20mA (2 wire)	+24 V dc nom. + 18-28V.	300Ω @ 24V.
(3 wire sink)	+24 V dc nom. + 13-28V.	950Ω @ 24V.
(3 wire source)	+24 V dc nom. + 13-28V.	300Ω max.

Sensors supplied with access to output 'zero' and 'span' calibration adjustments as standard. No access option available.

### CONNECTOR/CABLE OPTIONS

Connector - Hirschmann GD series IP65  
 Cable with M12 gland or short gland IP67  
 Cable length >50 cm – please specify length in cm

### MOUNTING OPTIONS

Flange, Body Tube Clamp.

**PUSH ROD OPTIONS** – standard retained with M4x0.7 female thread Sprung loaded (spring supplied loose), Dome end (sprung loaded) or Free.

Output Characteristic - Standard

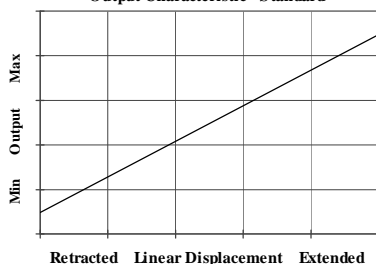

Output Characteristic - Reverse option

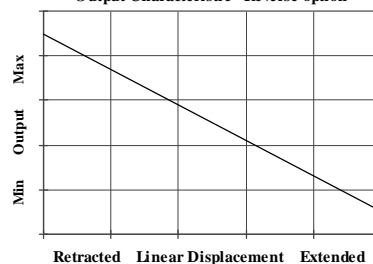

For further information please contact:

[www.positek.com](http://www.positek.com) [sales@positek.com](mailto:sales@positek.com)

Tel: +44(0)1242 820027 fax: +44(0)1242 820615

Positek Ltd, Andoversford Industrial Estate, Cheltenham GL54 4LB U.K.

# LIPS® SERIES P103 Short Stroke Position Sensor

a	b	c	d	e	f	g	h	j	k
P103 . Displacement Output Adjustments Connections Option Option Option Option Option Z-code									

a Displacement (mm)		Value
Displacement in mm	e.g. 0 - 22 mm	22
b Output		
Supply V dc V <sub>s</sub> (tolerance)	Output	Code
+5V (4.5 - 5.5V)	0.5 - 4.5V (ratiometric with supply)	A
±15V nom. (±9 - 28V)	±5V	B
+24V nom. (13 - 28V)	0.5 - 9.5V	C
±15V nom. (±13.5 - 28V)	±10V	D
+24V nom. (18 - 28V)	4 - 20mA 2 wire	E
+24V nom. (13 - 28V)	4 - 20mA 3 wire Sink	F
+24V nom. (9 - 28V)	0.5 - 4.5V	G
+24V nom. (13 - 28V)	4 - 20mA 3 wire Source	H
c Calibration Adjustments		Code
Accessible - default		blank
Sealed		Y
d Connections Cable* or Connector		Code
Connector	IP65 DIN 43650 'C'	J
Cable Gland	IP67 M12	Lxx
Cable Gland	IP67 Short	Mxx
*Supplied with 50 cm as standard, specify required cable length specified in cm. e.g. L2000 specifies cable gland with 20 metres of cable. Nb: restricted cable pull strength.		
e Housing		Code
Standard - default		blank
Flange Mount		N
f Body Fittings		Code
None - default		blank
Body Clamps - 1 pair		P
g Sprung Plunger		Code
None - default		blank
Spring Extend	Captive plunger only.	R
h Plunger Fittings		Code
None - default		Female Thread M4x0.7x7 deep
Dome end	Required for option 'R'	T
j Plunger Options		Code
Captive - default		Plunger is retained
Non-captive		Plunger can depart body
		V

k Z-code	Code
Connector IP67 M12 IEC 60947-5-2 must have options 'Y' & 'J'	Z600
Connector IP67 M12 IEC 60947-5-2 must have option 'J'	Z601
± 0.1% @20°C Independent Linearity displacement between 10mm & 50mm only!	Z650
Connector with cable option 'J' with length required in cm i.e. J100 specifies connector with 100cm of cable.	Z999

# Installation Information

## LIPS<sup>®</sup> P103 SHORT STROKE LINEAR POSITION SENSOR

Output Option	Output Description:	Supply Voltage: $V_s$ (tolerance)	Load resistance: (include leads for 4 to 20mA O/Ps)
A	0.5 - 4.5V (ratiometric with supply)	+5V (4.5 - 5.5V)	$\geq 5k\Omega$
B	$\pm 5V$	$\pm 15V$ nom. ( $\pm 9 - 28V$ )	$\geq 5k\Omega$
C	0.5 - 9.5V	+24V nom. (13 - 28V)	$\geq 5k\Omega$
D	$\pm 10V$	$\pm 15V$ nom. ( $\pm 13.5 - 28V$ )	$\geq 5k\Omega$
E	4 - 20mA 2 wire Current Loop	+24V nom. (18 - 28V)	$\approx 0 - 300\Omega$ max. @24V ~ 1.2 to 6V across 300 $\Omega$ { $R_L$ max. = $(V_s - 18) / 20^{-3}$ }
F	4 - 20mA 3 wire Sink	+24V nom. (13 - 28V)	$\approx 0 - 950\Omega$ max. @24V ~ 3.8 to 19V across 950 $\Omega$ { $R_L$ max. = $(V_s - 5) / 20^{-3}$ }
G	0.5 - 4.5V	+24V nom. (9 - 28V)	$\geq 5k\Omega$
H	4 - 20mA 3 wire Source	+24V nom. (13 - 28V)	$\approx 0 - 300\Omega$ max. ~ 1.2 to 6V across 300 $\Omega$

Not all output options available - see product datasheet for full options list

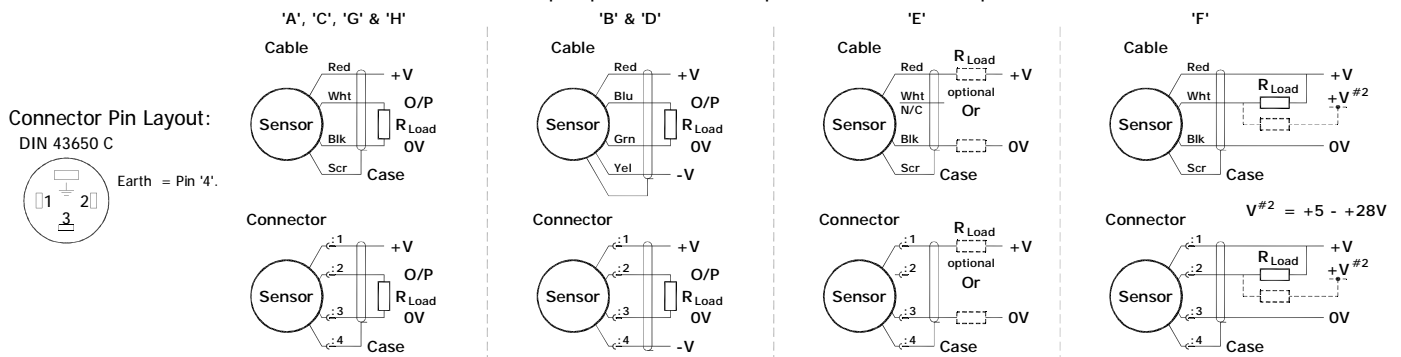

**Gain and Offset Adjustment:** (Where accessible - Typically  $\pm 10\%$  Min available)  
 To adjust the gain or offset use a small potentiometer adjuster or screwdriver 2mm across. Do not apply too much force on the potentiometers.

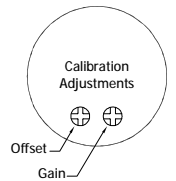

**Mechanical Mounting:** Flange mounted or by clamping the sensor body - body clamps are available, if not already ordered. The flange slots are 4.5 mm by 30 degrees wide on a 48 mm pitch.

**Output Characteristic:** Plunger extended, at start of normal travel, from mounting face by:  
 Standard body : 24.5 mm\*  
 Flanged body : 10 mm\*

\*Note: where ball end option is fitted add 5 mm.

The output increases as the plunger extends from the sensor body, the calibrated stroke is between 2 mm and 50 mm.

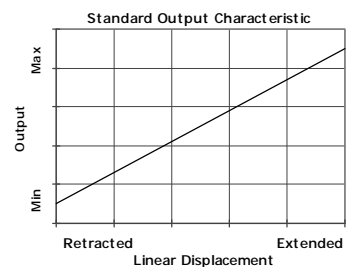

**Incorrect Connection Protection levels:-**

- A Not protected – the sensor is not protected against either reverse polarity or over-voltage. The risk of damage should be minimal where the supply current is limited to less than 50mA.
- B & D Supply leads diode protected. Output must not be taken outside  $\pm 12V$ .
- C & G Supply leads diode protected. Output must not be taken outside 0 to 12V.
- E, F & H Protected against any misconnection within the rated voltage.